

Australian Natural Disasters Organisation

RESCUE HANDBOOK

Australian Government Publishing Service Canberra 1975

OTHER AUSTRALIAN NATURAL DISASTERS ORGANISATION HANDBOOKS

GENERAL INFORMATION (1972)

THE WARDEN SERVICE (1970)

WELFARE (1967)

CIVIL DEFENCE COMMUNICATIONS

Part II Signal Centre Organisation and
Procedure (1966)

Part III Telephone and Radio Telephone
Procedure (1969)

Part VIII Communications in the Local
Controller's Organisations (1972)

RADIOLOGICAL DEFENCE MANUAL
(1968)

LOCAL HEADQUARTERS (1973)

FIELD CABLE (1975)

7314
MEDICAL

AMENDMENTS

| <i>Amendment number</i> | <i>Date of amendment</i> | <i>Date of insertion</i> |
|-------------------------|--------------------------|--------------------------|
| | | |

This Handbook deals with the organisation, duties and techniques of the Rescue Service. A knowledge of the overall organisation of Emergency Services and of First Aid is essential for all Rescue personnel.

ISBN 0 642 01001 3

Printed by Watson Ferguson & Co., Brisbane

Contents

| | <i>Page</i> |
|---|-------------|
| CHAPTER 1 ORGANISATION | |
| Aim | 1 |
| Functions | 1 |
| Column Organisation | 1 |
| CHAPTER 2 EQUIPMENT | |
| Personal | 5 |
| Manpack | 5 |
| First Aid | 6 |
| Light Rescue—Vehicle | 6 |
| Heavy Rescue—Vehicle | 6 |
| Radioac | 8 |
| CHAPTER 3 THE RESCUE PLAN | |
| Reconnaissance | 9 |
| Stages of Rescue | 11 |
| Calling and Listening Technique | 13 |
| CHAPTER 4 ROPES, CHAINS AND SLINGS | |
| Cordage | 15 |
| Steel Wire Rope | 16 |
| Care and Maintenance of Cordage | 16 |
| Chain Slings | 19 |
| Terms used in connection with Ropes | 20 |
| Knots and Lashings | 21 |
| CHAPTER 5 CASUALTY HANDLING | |
| Classification | 29 |
| Blanketing a Stretcher | 30 |
| Lashing a Stretcher | 32 |
| Moving a Stretcher over Debris | 33 |
| Moving a Stretcher in Confined Spaces | 35 |
| Passing a Stretcher over a Gap | 35 |
| Improvised Stretchers | 35 |
| Loading a Stretcher | 39 |

CONTENTS—continued

| | Page |
|--|------|
| Rescue Techniques—One Man | 45 |
| Rescue Techniques—Two Men | 50 |
| CHAPTER 6 RESCUE FROM HEIGHTS | |
| Chair Knot | 55 |
| Two Point Vertical Suspension | 57 |
| Four Point Horizontal Suspension | 57 |
| Ladder Slide | 58 |
| Ladder Hinge | 59 |
| Leaning Ladder | 61 |
| Ladder Derrick | 62 |
| Flying Fox | 64 |
| Jibs | 67 |
| CHAPTER 7 THE REMOTE BREATHING APPARATUS | |
| | 69 |
| CHAPTER 8 DEBRIS | |
| Debris | 73 |
| Rescue by Debris Clearance | 74 |
| The Debris Crawlway | 76 |
| Rescue from Basements | 76 |
| General Precautions | 77 |
| CHAPTER 9 LISTING AND HAULING EQUIPMENT | |
| Levers | 78 |
| Hydraulic Rescue Equipment | 78 |
| Rules for Jacks | 83 |
| Holdfasts | 84 |
| Picket Holdfasts | 84 |
| Buried Holdfasts | 86 |
| Improvised Holdfasts | 87 |
| Blocks and Tackle | 87 |
| Derricks—Sheers—Gyns | 93 |
| The Tirfor | 100 |

Page

CHAPTER 10 TEMPORARY SHORING AND ELEMENTARY DEMOLITION

| | |
|---------------------------------|-----|
| Raking Shore | 107 |
| Flying Shore | 110 |
| Vertical Shore | 112 |
| Strutting of Openings | 113 |
| Elementary Demolition | 114 |
| Demolition | 114 |

CHAPTER 11 CUTTING GASES: SAFETY REGULATIONS STORAGE AND USE

| | |
|---------------------|-----|
| Oxygen | 116 |
| Acetylene | 117 |
| Cylinders | 119 |

CHAPTER 12 LADDERS

| | |
|---|-----|
| Short | 120 |
| Extension | 121 |
| Testing 11 m Extension Ladder | 121 |
| Angle when Raised | 122 |
| Securing | 122 |
| Anchoring | 124 |
| Climbing | 124 |
| Erection | 124 |
| Halving | 125 |

CHAPTER 13 DAMAGE TO BUILDINGS

| | |
|--|-----|
| Types of Building | 126 |
| 'V' Type Collapse | 128 |
| 'Horizontal' Collapse | 129 |
| 'Lean-To' Collapse | 129 |
| Hazards from Damaged Utilities | 130 |

CHAPTER 1 ORGANISATION

Aim

The aim of the Rescue Service is to release the maximum number of trapped persons in the minimum time.

Functions

The primary functions of the Rescue Service are—

- (a) To save life by the rapid extrication of trapped persons.
- (b) To administer life-saving first aid to trapped persons during the course of rescue operations.

The secondary functions, once life-saving tasks have been completed, may include:

- (a) The recovery of the dead.
- (b) The temporary support or demolition of damaged structures where collapse may endanger life or obstruct essential traffic.
- (c) Provision of support for specialist parties (e.g. cave-neers, debris clearance parties, etc.).
- (d) Ensuring that all personnel know how to deal with water, gas, electricity or other utilities which could endanger life or impede rescue operations.

Column Organisation

The Rescue Service is a mobile force organised into Light and Heavy Columns.

The basic unit is the Rescue Party of eight men, including leader and deputy leader, equipped with manpacks to enable essential tools to be carried over debris.

In both Light and Heavy elements of the service there will be six Rescue Parties in a platoon and in each column there will be six platoons. Under certain circumstances it may be desirable to divide the column into two units; in which case company headquarters will be introduced and each company will consist of three platoons.

All Rescue Personnel should be issued with the personal clothing and equipment listed in Chapter 2.

**RESCUE COLUMN (LIGHT)
COLUMN HEADQUARTERS**

Coln R.O. & D/Coln R.O.
4 D.Rs.
Driver
2 Motor Mechanics

COY H.Q.
(IF REQUIRED)
Coy R.O.
D. Coy R.O.
Driver
2 D.Rs.

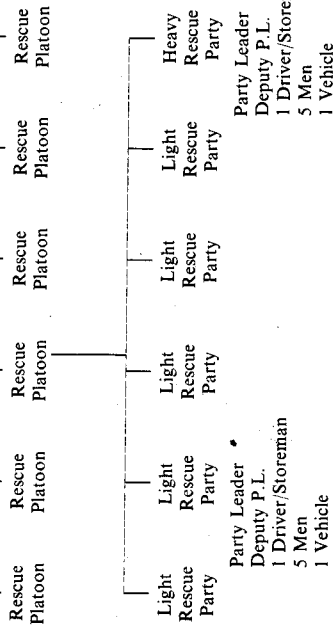

In a Light Rescue Column five parties in each platoon will be equipped with Light Vehicle Equipment and the sixth party with Heavy Vehicle equipment as listed in Chapter 2.

In Heavy Rescue Column all six parties in each platoon will be equipped with Heavy Vehicle equipment.

This organisation should enable Light Rescue Columns to clear roads and extricate most casualties in areas of light to moderate damage. The five Light Parties in each platoon will concentrate on the lightly trapped in bungalow-type buildings while the sixth party attempts more difficult heavily trapped casualties in the same area. The five Light Parties when they have completed their tasks can assist their heavy element until redeployed. It must be remembered that this work could continue 24 hours a day for a period of many days in a major disaster.

The Heavy Rescue Column will be deployed into areas in which heavy damage has occurred. Each party has equipment to enable it to tackle any problem and, in addition, sufficient to expand to the equivalent of three parties utilising sixteen survivors from the area.

The overall proportion of Heavy to Light Platoons will depend on the analysis of zones but it should never exceed 1 : 5, thus ensuring a very considerable economy of equipment.

The Rescue Service will be represented at all levels of control. A rescue officer will act as adviser to each Controller in the operational area. He will take command of all rescue personnel located or deployed in his area of responsibility. This officer will be known as the Chief Rescue Officer, e.g. Chief Rescue Officer—No. 1 Group.

The following diagram shows the headquarters establishments and column organisations for both Light and Heavy elements:—

RESCUE COLUMN (HEAVY)

COLUMN HEADQUARTERS

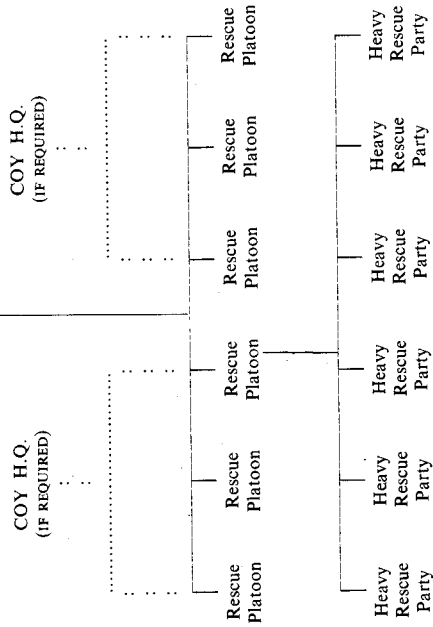

4

CHAPTER 2 EQUIPMENT

The Australian Government is currently providing rescue equipment which is not otherwise readily available and this will be issued to the Rescue Service by State and Territory Emergency Service Organisations. Rescue personnel are expected to complete their equipment from local resources. It should not be necessary to hold this extra equipment, but only to know where it can be obtained quickly when needed. This applies also to vehicles for the Rescue Service.

The full scale of equipment is as follows:

Personal Clothing and Equipment

Boots
 Gaiters
 Helmet
 Overalls
 Knife, clasp with marlin spike and lanyard
 Lantern, hand, electric
 Webbing equipment, including manpack, first aid haversack and water bottle

Manpack Equipment

Auger, 25 mm
 Bands, webbing (sets of 2)
 Bar, wrecking, 600 mm
 Blanket
 Bond, wire, 4 mm × 5 m
 Chisel, cold, 25 mm blade, 200 mm-300 mm stem
 Cord, sash, 4-6 m
 Gloves, debris
 Goggles, dust
 Hammer, club 1 kg
 Hatchet, case opening
 Mask, dust
 Pliers, side cutting, insulated
 Rope, 12 mm × 12 m
 Saw, multi-purpose

5

First Aid Equipment

- *Baking soda tablets, plastic container of 50
- 12 Bandages, calico, 100 mm × 5.5 m
- Bandages, constrictor
- 3 Bandages, triangular
- Butterfly closures
- 25 Casualty labels
- Crayon wax
- 6 Dressings, first field
- 9 Dressings, shell
- Drinking vessel, 250 ml
- *6 Morphia Syrettes (¼ grain)
- *Ointment, Tetracaine Ophthalmic, tube
- Pencil, indelible
- *Salt tablets, plastic container of 50
- 5 Sheeting, sterilised, 900 mm × 900 mm, in plastic bag

Light Vehicle Equipment

The following equipment will be taken by each Light Rescue Party in their vehicle and carried forward as necessary—

- Bar, 25 mm × 1.5 m, chisel point
- Hammer, 3 kg
- Ladder, 2.5 m-4.5 m, extension
- *Rations, hard—3 days' supply
- Rope, 60 m × 16 mm
- Shovel, short-handled
- Snatch block, 80 mm
- Stretcher, folding

Heavy Vehicle Equipment

The following equipment will be taken by each Heavy Rescue Party in their vehicle and carried forward as necessary—

- Axe, felling—2 kg
- 6 Bars, picket, 25 mm × 1.5 m, steel
- 2 Bars, crow, 1.7 m, chisel point
- Bar, steel, 12 mm × 3 m

*Not in peacetime. Will be provided if necessary.

- 12 blankets, woollen
- 8 Blocks, wooden, spacing
- Blocks, snatch, 80 mm
- Box, nails—mixed—1 kg 50 mm
- 1 kg 80 mm
- 1 kg 100 mm

4 Buckets

- Chains, 1.8 m, with ring and hook, tested 20 kN
- Chains, 1.8 m, with ring and hook, tested 7.5 kN
- Cutters, bolt, 16 mm
- Cutters, pipe, 12 mm-50 mm
- 12 Cords, sash, 4.6 m
- Chisel, plugging
- Gloves, rubber, insulation
- Hammer, claw
- Hammer, sledge, 3 kg
- Ladder, 2.5 m-4.5 m, extension
- Ladder, 6 m-11 m, extension
- 3 Mattocks, cross grubbing
- 3 Poles, derrick, 6 m × 76 mm—with butt min. of 100 mm
- Hydraulic Rescue Kit

Consisting of:

- Hand-operated hydraulic pumps with modified shortened reservoir and clip to hold handle for carrying position (B/Hawk Part P76 modified) 2
 - 1.8 m hoses with ZH604 coupler (B/Hawk Part No. Z913) 2
 - Short 10 t rams with ZR400 coupler, Z410 cap, (modified B/Hawk Part No. RC159) 2
 - Screwed adaptors to suit Base plate and Plunger Toes 2
 - Serrated saddles for ram 2
 - Hydraulic Wedgie with ZR400 coupler and Z410 cap (B/Hawk Part No. SA4) (modified with high carbon steel jaws) 1
 - Deep reach spread jaw (without built-in ram and high carbon steel jaws) 1
 - Flat Base (B/Hawk Part No. Z14) 2
 - Ram Toes (B/Hawk Part No. Z30) 2
 - Plunger Toes (B/Hawk Part No. Z9) 2
- (All above to be contained in metal carrying kit)

CHAPTER 3 THE RESCUE PLAN—STAGES OF RESCUE

Successful rescue work depends principally on two things: first a quick but thorough appraisal of the situation by the person in charge, i.e. reconnaissance, plus systematic working plan.

This chapter deals with rescue reconnaissance from the point of view of the rescue party leader. It is the basis of all good rescue. First class rescue reconnaissance brings successful results and that point cannot be over-emphasised throughout all stages of training.

The magnitude of the task and the limiting time factor call for a rapid assessment throughout. Rescue reconnaissance is allied to all stages of the rescue plan, but there is no suggestion that all the stages must be followed rigidly. The 'Five Stages of Rescue' are a guide, but it is more than likely that where a nuclear weapon has exploded the Rescue Service will be primarily concerned with the second, third and fourth stages. It is indeed doubtful if stage five (general debris clearance) will be called for until such time as the whole area is cleared.

The rescue plan must always be flexible in order to ensure that rescue personnel do not exceed the pre-set dose limit of radiation (see *Radiological Defence Manual*, Pt 1, paragraph 32) or the higher dose when it is authorised to enable them to complete an important task already in hand.

Initial Reconnaissance

The party leader's reconnaissance is an attempt to arrive at an accurate assessment of the numbers and whereabouts of casualties, and such factors as danger from gas, flooding of basements, overhanging walls, etc. which may endanger either survivors or his party. It is essential that every member of a rescue party should be thoroughly grounded in rescue reconnaissance as in many instances, especially where large areas of damage are being dealt with, the leader of a party may be responsible for a considerable number of buildings and men deployed by him must be able to do their own reconnaissance of the task on which they have been set to work.

Information

Normally the initial information will be given by a Patrol Warden.

Pump, stirrup
*Rations, hard—3 days' supply

2 R.B.A. Sets

Rope, manilla or sisal, 16 mm-60 m

Rope, manilla or sisal, 24 mm-60 m

12 Ropes, manilla or sisal, 12 mm-12 m

2 Ropes, wire, 16 mm × 12.25 m

Saw, hand

Saw, bushman's, 900 mm

Saw, cross-cut, 1.8 m

Shackle, 'D' type, tested 2 tonnes

2 Shovels, medium

2 Shovels, short

Spanner, crescent, 380 mm

2 Screwdrivers, 230 mm

6 Stretchers, folding

Tarpaulin, 3 m × 3 m approx.

Tape, measuring, 2 m

Tirfor, hauling and lifting, type T.13 and snatch block

Wrench, Stillson, 762 mm

Wheelbarrow

8 Wedges, wooden

Optional Equipment

Chain saw

Oxy-acetylene cutting torch, complete

Acetylene cylinder

2 Oxygen cylinders

Portable pump, 18 000 litre per hour

Radiac Equipment

Coln H.Q. 6 dosimeters (0-600 r). One for each Officer and each D.R. 1 charging unit to be held by the driver.

Coy H.Q. (if required) 4 dosimeters (0-600 r). One for each Officer and D.R. 1 charging unit to be held by the driver.

Platoon H.Q. 3 dosimeters (0-600 r). One for each Officer and the D.R.

Rescue Party 1 dosimeter (0-600 r) to be carried by Party Leader.

*Not in peacetime. Will be provided if necessary.

In addition to this source, valuable information may be obtained from reliable witnesses, e.g. police officers, relatives, neighbours, etc.

In certain cases, especially in large-scale damage by modern weapons, the leaders may be directed to definite tasks, e.g. a position where large numbers of people are known to seek shelter or congregate together, or where people are endangered by the spread of fire, or any other hazards.

Observation

Having deployed his party, the leader will make a further reconnaissance with a view to the redeployment of his men.

Men deployed on a particular building must make careful observation of how that building has collapsed. This should be done in the light of any information available concerning probable casualties. First, some attempt should be made to locate and identify the parts of the building and especially those parts in which casualties are reported to be. This will enable a rough idea to be obtained as to where casualties might be found in relation to the various parts of the damaged structure.

The art of rescue lies in being able to identify and exploit to the maximum all debris formation such as voids, etc. which can be used to facilitate access to the casualty once his whereabouts has been fixed by information and inference.

Most rescue work has to be conducted under conditions of great difficulty and confusion, often made worse by darkness. As a result, it is usually difficult to form a true picture of the position and it is, therefore, highly important that rescue operations should be carried out systematically in stages and to a definite plan.

On first approach, even the best leaders tend to over-estimate the difficulties owing to the appalling confusion, and the apparent magnitude of the job. This mental reaction is quite natural. And it is at such times that a leader requires to exercise all his qualities of coolness, perseverance and courage and to make full use of the knowledge gained in his previous experience and training. At the same time, the party, to avoid harassing the leader, must display confidence in him and must help him, especially, by remembering:

- (i) Not to ask unnecessary questions.

- (ii) Generally to give the leader advice only when he asks for it.
- (iii) To listen attentively, so that instructions need be given once only.
- (iv) To keep together on the job and not to be missing when required.

Rescue by Stages

No standard set of rules can be devised to give leaders sure guidance on how to tackle every job, but by proceeding in stages according to a regular plan they are less liable to overlook important points, and are more likely to be able to appreciate and organise appropriate action. The principle of applying the art of reconnaissance to each successive stage will operate throughout. Rescue operations should proceed as nearly as possible in the following five stages. They are framed so as to be generally applicable to any set of circumstances and to any rescue task from start to finish. They are easily memorised by reference to the mnemonic C-R-E-S-T.

- C—Clearance of surface casualties.
- R—Rescue of lightly trapped.
- E—Exploration of likely survival points.
- S—Selected debris removal.
- T—Total debris clearance.

Stage 1—Clearance of Surface Casualties

The task of caring for casualties properly belongs to wardens and the Ambulance and First Aid Service but if necessary the Rescue Party must be prepared to care for casualties who need immediate attention.

Stage 2—Rescue of Lightly Trapped

This involves (a) the recovery of those who are lightly trapped and (b) the searching of slightly damaged buildings to ensure that no casualties within them are unattended. Once casualties have been seen or heard, or their whereabouts definitely ascertained, every endeavour should be made to maintain contact until they are released. In carrying out this stage, a speedy but careful examination of the damaged structures is needed in order to determine the best and safest approach. There is always the danger of fire owing to hot coals etc. from open

fires having been scattered by the blast. In houses where gas is used there is danger of gas poisoning and explosion owing to (i) lights, stoves, etc. having been blown out by the blast, (ii) house mains having been fractured by earth shock. It is for this reason that rescuers must not smoke or use naked lights when searching a building. Normally, the search should commence at the lowest portions of the building and be continued upwards until every room and every possible position in which casualties may be has been explored.

Marking Buildings after Search

Buildings which have been thoroughly searched should be so marked and the following standard marking must be used. A capital letter 'S' chalked near the entrance will denote that the building has been searched and cleared of casualties. This will be underlined and underneath will be chalked the initial letter of the service responsible for the search, thus:

$\frac{S}{W}$ searched by Warden Service.

$\frac{S}{F}$ searched by Fire Service.

$\frac{S}{P}$ searched by Police.

$\frac{S}{FA}$ searched by Ambulance and First Aid Service.

$\frac{S}{R}$ searched by Rescue Service.

Where searchers find dangerous conditions, e.g. leaning walls, damaged staircases, holes in floors, escaping gas, etc., they should chalk the letter 'D' after the standard marking.

Thus:

$\frac{S}{W} D$

Buildings in which dangers exist should be marked in a prominent position on all sides where entry is likely to be made. In addition to the marks, a piece of board or some improvised barricade with the word 'DANGER' chalked or written on it, or even string across an opening, will assist in warning anyone who has occasion to enter the building.

If debris is present in sufficient quantity to hide casualties, only mark those parts of the building which have been thoroughly searched.

Stage 3—Exploration of Likely Survival Points

All likely survival points where persons may have taken refuge and in which they may be trapped, either injured or uninjured, must be searched. Too much stress cannot be laid on the need for searching all likely places for casualties who may still be alive, and of affecting their release before any attempt is made to rescue victims who have little chance of surviving. This does not mean that every nook and cranny must be searched for possible casualties, but likely places must be fully explored.

It should be remembered that casualties may be found who have received severe crush injuries from fallen masonry, brickwork, beams, party walls, heavy furniture, etc. These persons will be suffering from shock and their breathing passages may be clogged by the dust contained in the debris, in which case these passages must be cleared. Persons suffering from crush injuries need special treatment before release, if practicable.

Calling and Listening Techniques (Fig. 1)

When it is known that persons are still missing, and the rescuers are confronted with a major collapse of premises, the casualties may be trapped within the voids formed by the collapsing building. A 'calling and listening' period should be introduced; this has in the past saved many lives and is carried out in the following manner: the leader places such men as may be available at suitable vantage points around the area in which the persons may be trapped. He then calls out 'SILENCE . . . SILENCE FOR RESCUE', and each man as directed by the leader calls 'RESCUE PARTY HERE . . . CAN YOU HEAR ME?' All others listen intently for any reply. If none is heard it is a good plan to tap on a wall, or on any gas or water pipe, beam, etc. running into the debris, all of which are good conductors of sound, and again listen for an answer. On hearing a reply, each listener points to the place from which he thinks the sound came, thus 'pin-pointing' the position. Once contact has been established with a trapped person, it should be maintained.

CHAPTER 4 ROPES, CHAINS AND SLINGS

The term rope is used for both fibre and wire ropes with which Rescue Parties are supplied. The term cordage is used to denote fibre ropes only.

Cordage stretches very considerably under load; the stretch in a new rope, when subjected to its working stress, is about one-twentieth of its length.

Steel wire rope (S.W.R.) is stronger and less liable to stretch than cordage but it is not so flexible and, therefore, more difficult to handle.

Both cordage and S.W.R. require continual attention and care if their usefulness is to be maintained.

Cordage

Cordage may be made of a variety of materials such as manilla, hemp, sisal, cottons, coir or nylon. Whatever the material, the rope is made by twisting several fibres together to form a yarn, several of which are then twisted to form a strand and three or more strands are twisted together to form a rope.

The 'lay' of a rope, which can be either right or left handed, depends on the way the strands are twisted together during manufacture.

Safe Working Load of Cordage

The size of cordage is denoted by its diameter (D) in millimetres and $D^2/100$ equals its safe working load (SWL) in kilonewtons (kN).

Example (i) New, dry 16 mm cordage

$$\frac{(\text{Diameter in mm})^2}{100} = \text{SWL in kN}$$
$$\frac{16 \times 16}{100} = 2.6 \text{ kN (approx.)}$$

Example (ii) Saturated 16 mm cordage with sharp bend

$$\frac{(\text{Diameter in mm})^2}{100} \times \text{Safety Factor} = \text{SWL in kN}$$
$$\frac{16 \times 16}{100} \times \frac{2}{3} = 1.75 \text{ kN (approx.)}$$

15



Figure 1. Leader and Three Men using Calling and Listening Technique

Use of Dogs

Specially trained dogs have been used with conspicuous success on a number of occasions and proved their value as an adjunct to rescue reconnaissance, especially in the 'third stage of rescue'.

Stage 4—Selected Debris Removal

If casualties are located, their recovery will entail removing debris according to:

- (i) The location of the casualty.
- (ii) The layout of the building.
- (iii) The way in which the building has collapsed.

Stage 5—Total Debris Clearance

Where it is still impossible to account for all missing persons it may be necessary to strip the site methodically. When debris has been relocated, the pile should be suitably marked.

14

Care and Maintenance of Cordage

To ensure the efficiency of fibre ropes, ALWAYS:

- (a) Stretch a new rope throughout its length before using it. To do this attach one end to a swivel hook (to allow of twisting) and haul on the rope.
- (b) Avoid cutting a rope unless it is essential to do so. If it is necessary, ensure that the cut end is whipped as soon as possible to prevent fraying. As a temporary measure to prevent fraying, tie a figure of eight knot near the end of the rope. Adhesive tape is also useful as a quick temporary whipping.
- (c) Avoid permanent knots in a rope, as these considerably reduce its strength.
- (d) Do not attempt to force a thick rope through a block made for a smaller rope. This causes chafing of the rope and lessens its strength.
- (e) Avoid passing a rope over a sharp edge. If it is necessary to do this protect the rope with a sacking or a piece of rounded timber. (chafing piece).
- (f) Avoid sudden jerks or violent stress on the rope as this weakens both the rope and any tackle used with it.
- (g) As far as possible, keep a rope dry. If it gets wet, do not attempt to dry it in front of a fire. Spread it on a ladder, laid horizontally off the ground to enable the air to circulate freely round the rope.
- (h) Store fibre ropes under cover off the floor, preferably on racks in a place free from extremes of temperature and out of contact with materials containing any acid or strong alkali, e.g. creosote; also free from rats if possible.
- (i) Examine ropes regularly for external damage and rotting of fibres.
- (j) If coiled rope has to be left in a place where it may be exposed to the weather, cover it with tarpaulin or some other form of protection.
- (k) Whenever a rope has been used, ensure that it is clean and dry before it is coiled and put away.

Steel Wire Rope (SWR), Chains and Slings

Steel wire rope consists of a number of strands (normally six) with a fibre core. Each strand consists of a number of steel wires—the com-

monest form of construction being 6/7 indicating six strands of seven steel wires with a fibre core. During manufacture, wires and strands are either coated with lubricant to prevent corrosion and friction in the rope or are galvanised.

The size of SWR is measured by its diameter (D) in millimetres and $D^2/10$ equals its safe working load in kilonewtons

Example (i) New 14 mm SWR

$$\frac{D^2}{10} = \text{SWL in kN}$$

$$\frac{196}{10} = 19.6 \text{ kN}$$

Example (ii) New 14 mm SWR when sharply bent

$$\frac{D^2}{10} \times \frac{2}{3} = \text{SWL in kN}$$

$$\frac{196}{10} \times \frac{2}{3} = 13 \text{ kN (approx.)}$$

Care in Use

Wire ropes should never be bent sharply at any point. As a general rule, the smallest diameter round which a wire rope is to be bent should be approximately six times the circumference of the rope; anything smaller than this will set up undue strain on the steel wires. With a 16 mm diameter (i.e. 50 mm circumference) wire rope, the minimum diameter about which it can be bent without causing harm to the rope is 300 mm. Care must be taken, therefore, by packing or otherwise, to ensure that the rope is not damaged when it has to be bent round any object.

Inspection of Wire Ropes

Starting at one end of the rope:

- (a) Check the shackle used with the rope to see that it has not suffered distortion or strain, and that the shackle pin is in good condition and can be easily screwed home by hand.
- (b) Examine the thimble and splice. The splicing cannot be seen as it is covered by the wire binding or 'serving', but if the serving is loose or shows signs of bulging it is probable that this splice is starting to come undone.
- (c) Working along the rope a hand's breadth at a time, see that it is

reasonably round, i.e., has not been flattened in use or suffered distortion which causes the wires to open and thus weaken the rope.

(d) Look for broken wires. A broken wire in a rope should always receive prompt attention. Delay may lead to serious accidents, and will certainly cause damage to other wires. The method often used to deal with a broken wire by nipping it off with pliers is by no means the best way, for this leaves a little jagged end. To save time and trouble, simply bend the wire backwards and forwards with the fingers until it breaks, or, in the case of a short end, use a piece of wood. In this way the wire breaks inside instead of outside the rope, and the end is left tucked away between the strands, where it can do no harm to the other wires or personnel.

(e) Look for kinks. When a rope has been kinked, the kink may pull out when used and the rope appear to be reasonably straight although the structure of the rope has been distorted and damaged. The length affected by kinking may be only a few inches, and yet cause this part of the rope to be weak. The presence of a kink is best detected when the rope is lying slack on the ground.

Rope found defective should be labelled and placed apart from ropes in good condition until they can be examined by a competent person.

Storage of Wire Ropes

Wire ropes should be stored under cover in a clean dry place and in such a manner that no part of the rope rests on the ground. They must never be stored by laying on concrete, ash, clinker, or coke breeze floors as these materials have a bad effect on the steel. Periodical examination of all wire ropes in store is necessary to ensure that the ropes are not becoming corroded.

Records

The result of all inspections, including details of any damage found, should be recorded in the Register of Chains, Ropes and Lifting Tackle kept by all Heavy Rescue Parties.

Slings

For slinging heavy loads to be lifted by apparatus set up by rescue parties, chains and wire slings are carried in heavy rescue vehicles.

Chain Slings

The chain slings supplied are of the single leg type with a hook at one end and a ring at the other. The approximate formula for finding the SWL of a chain is:

$$W = \frac{D^2}{13}$$

Where W = SWL in kilonewtons

D = diameter of the smallest link in millimetres

$$\text{Example } 12 \text{ mm link chains} \\ \frac{12 \times 12}{13} = 11 \text{ kN (approx.)}$$

To lift a load with a chain sling

- (a) The ring of the sling can be placed on the hook of the lifting tackle and the sling hook placed in the ring, or
- (b) the ring of the sling can be placed on the hook of the lifting tackle and the sling hook placed around the chain after passing the chain around the article to be slung. When the latter method is used, the bight should be forced down as low as possible to ensure a firm grip on the load.

Shortening a chain sling

Chain slings should never be shortened by tying a knot in the chain as this will cause excessive bending stresses in some of the links and may result in damage or fracture.

Wire Rope Slings

It may be necessary to improvise slings using the 16 mm SWR supplied to all Heavy Rescue Parties.

General Precautions in Use of Slings

The method of slinging any given object must vary according to circumstances, but certain general rules and precautions should be observed to ensure safe working.

- (i) The size and therefore the strength of the sling selected will be governed by the weight of the load.
- (ii) Timber packing must be inserted between the sling and the edges of the load to prevent the sling coming in contact with sharp edges.

- (iii) Hooks must be moused (see below).
- (iv) Wire rope slings must not be bent round too sharp an angle and, to prevent this, timber packing must be used to ensure an even curve.
- (v) Carelessness in hoisting, e.g. shock lifting or snatching, must be avoided.
- (vi) Slings should not be dragged along a floor or the ground, and should never be pulled from under a load which, when lowered, is resting on the sling.

Improvisation

If chains or steel wire ropes are not available 12 m lashings can be used as slings provided a suitable number of turns are made to ensure the safe working load.

Terms used in Connection with Ropes

Anchored Fastened to some immovable object, such as a large tree, post or a well-driven picket.

Bight An open loop in a rope (Fig. 1a). Running end

Fraping The binding together of a lashing between two poles.

Dawl The act of pulling on a rope.

Hitch A closed loop on a rope; a simple fastening of a rope around some object by winding and crossing one turn over another turn so that one bites on the other without actually knotting the rope.

Marrying Twisting the running end around the standing part in the same direction as the lay of the rope.

Mousing (Fig. 2). Tying a piece of cord across the jaws of a hook to prevent a rope or sling from jumping out when the weight is temporarily supported.

Parcelled When part of a rope is wrapped to prevent chafing.

Paying out or Easing To ease off or slacken a rope.

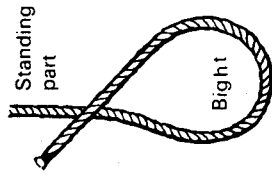

Figure 1A, Bight

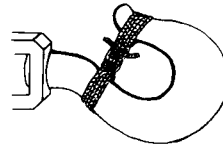
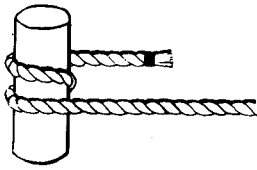

Figure 2. Mousing



Reeve The threading of a rope through pulley blocks or snatch blocks.

Round Turn (Fig. 3) One complete turn of a rope round a spar or another rope.

Running End The free end of a rope.

Standing Part. The part of a rope which is taking the load.

Whipping (Fig. 4) Binding the end of a rope with twine to prevent untwisting or fraying. Whipping is also used to bind the loose end of a rope to the standing part.

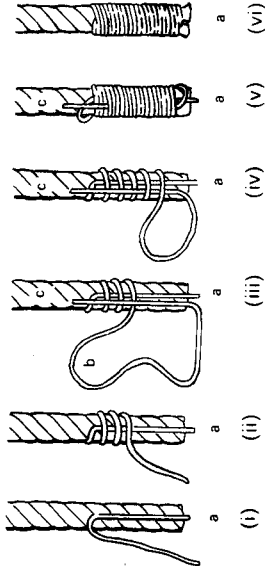

Figure 4. Whipping

Knots and Lashings

Rescue personnel should be familiar with the following rope knots and lashings and, by constant practice, must learn how to make and adapt them with speed and proficiency. Knots must always be tied tightly, dressed down and inspected. Remember a knot that does not look right almost certainly is incorrectly tied.

Half Hitch (Fig. 5)

This is formed by passing the short end of a rope around the spar (or around another rope) and under the standing part, so that, when pulled, one part of the rope binds the other.



Figure 5. Half Hitch

Clove Hitch (Fig. 6)

This forms the basis of many securing knots and can be used in the end of a rope or in the centre. To tie at the end of a rope, pass the running end over a pole bringing it out underneath the standing part. Pass the running end round the pole again above the first half hitch, bringing the running end under itself to tighten, pulling both the running end and the standing part. When tied thus in the end of a rope, it is a good anchoring knot and is easily untied. To tie in the centre of a rope, two loops are formed, one in the left hand (anti-clockwise) and one in the right hand (anti-clockwise), the latter being passed in front of the left-hand loop. Both loops are then passed over the pole and drawn tight.

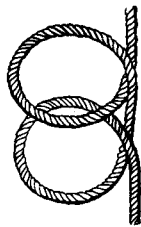

Figure 6. Clove Hitch

Round Turn and Two Half Hitches (Fig. 7)

This also is used for securing the running end of a rope to a spar or ring and is formed by a round turn on the spar or ring with two half hitches on the standing part of the rope. It has the great advantage of allowing a load to be adjusted using the round turn, then finally secured by making the two half hitches on the standing part of the rope.

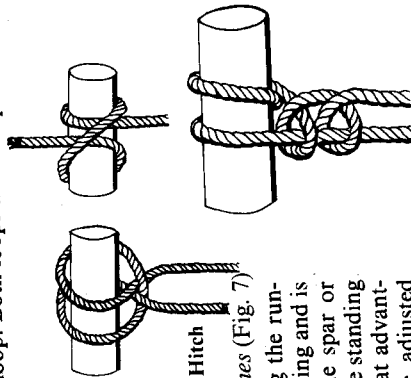

Figure 7. Round Turn and Two Half Hitches

Timber Hitch (Fig. 8)

This is a quickly made hitch used to secure a rope to a plank or pole, and is formed by making a half hitch on the standing part of the rope, leaving a long end which is twisted with the lay for a minimum of three turns around its own part of the hitch. When used for lifting spars, planks or poles, this hitch should be used in conjunction with a half hitch at the upper end of the spar.

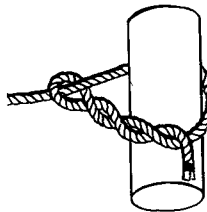

Figure 8. Timber Hitch

Double Sheet Bend (Fig. 9)

The Double Sheet Bend is used for joining ropes, regardless of size. It is made by forming a loop in the thicker of the two ropes and holding this in the left hand. Pass the running end of the other rope up through the loop and around both thicknesses of the thicker rope twice and then under its own standing part without overriding.



Figure 9. Double Sheet Bend

Thumb Knot (Fig. 10)

This is a simple knot tied in the end of a rope to stop the rope passing through a pulley block or temporarily to prevent fraying of an end. The knot is formed by making a loop and passing one end through it.



Figure 10. Thumb Knot

Figure-of-eight Knot (Fig. 11)

With the rope 'away' from you, take the standing part in the left hand palm upwards and the running end in the right hand. Pass the running end over the top of the standing part making a loop, then carry on with the running end round behind the standing part, over the top, then down through the loop which you have formed. Draw the running end tight and the knot should resemble the figure-of-eight. This knot is useful as a stop and is often used to prevent the end of a rope from running further through a block. It can also be used temporarily to prevent the end of a rope from fraying when the whipping has been lost. In general it is more useful than the Thumb Knot as it is easier to undo.



Figure 11. Figure-of-eight Knot

Reef Knot (Fig. 12)

A good general purpose knot, very useful in first aid and tying up parcels etc. It is formed using two running ends and the formula right over left, tuck in,



Figure 12. Reef Knot

left over right, tuck in, should always be used to avoid tying a granny knot.

Reef knots are easily untied by pulling one running end and a standing part on the same side. For this reason it is not good practice to join ropes with a reef knot—better, a double sheet bend.

Chair Knot (Fig. 13)

The chair knot is very important for emergency rescue work. One of its main purposes is to form an efficient and quickly made sling in which a person may readily be raised or lowered. The sling formed by this knot gives support to the chest and legs of the person being rescued.

It is formed by grasping the rope, near its centre, in the left hand, palm down. Approximately a metre from the left hand take the rope in the right hand, palm uppermost. Turn the left-hand palm upwards forming a loop (anti-clockwise), turn the right-hand palm down forming a loop. Pass the standing ropes through the loops of the opposite hand pulling them through, thus forming two loops with a knot in the centre. These loops are then adjusted to the required size and a half hitch is then made on each loop to lock them at their required size.

Initially, loops should be of equal size (knot placed in the centre of the chest and arms extended). The casualty is then slung, one loop under his arms and one under his knees. The knot should be midway between his nose and knees. The chair knot may also be used as a stretcher sling, made by forming a chair knot complete with half hitches, in the centre of a 12 m lashing. The sling is attached to the stretcher handles by means of half hitches and adjusted. The main lowering or lifting line is normally attached to the chair knot by making a round turn and two half hitches through the long legs of the knot.

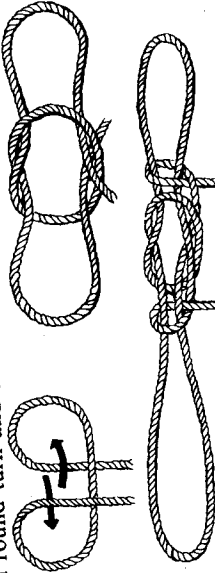

Figure 13. Chair Knot

Bowline (Fig. 14)

The bowline is one of the most important knots used in rescue work. It produces a non-slip loop which is always easy to undo, even though the rope be wet. The bowline is used extensively in making a life line around a person's waist and also for securing guide lines to stretchers.

The best way of learning to tie the bowline is to start by tying it around the waist. With the rope across the back of the waist and the running end in the right and the standing part in the left, tie the first half of a reef knot. Pull the running end sharply. This will produce a half hitch around the running end. Take the running end around the back of the standing part and down through the half hitch. Dress the knot by pulling the running end with one hand and the standing part with the other.

When this method has been mastered, time should be spent in tying the bowline around objects and finally tying the knot to make an open loop as in Fig. 14.

Lashings

Lashings are used mainly to secure two or more poles firmly together. The form of each type of lashing can best be understood by a careful study of the diagrams below and the appended explanation. The lashings are generally made by using the 12 m 12 mm lashing.

Square Lashing (Fig. 15)

This is used to lash together two poles that touch and cross at right angles.

Stage 1 Start with a clove hitch (a) round the standard, below the ledger, 'marrying' the ends as at (b). Take the 'married' ends up and around both standard and ledger as depicted by arrows.

Stage 2 Repeat this circuit three or four times working inwards on the standard until the gap is filled, keeping the rope as taut as possible.



Figure 14. Bowline

Stage 3 (a) Take three or four frapping turns (c) around the whole lashing between the spars, draw taut and finish with a clove hitch (d) on the ledger.

Stage 3 (b) The square lashing complete as viewed from the back.

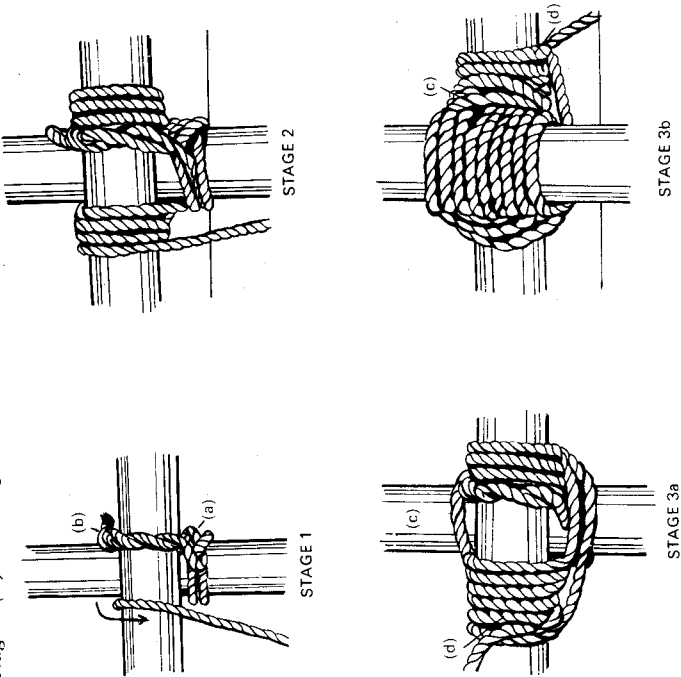

Figure 15. Square Lashing

Diagonal Lashing (Fig. 16)

This is used to lash together two touching poles at an angle, especially when their mode of use may cause them to spring apart.

Stage 1 Start with a timber hitch (a) round both poles horizontally, then take four vertical turns (b) and draw all taut.

Stage 2 Take four horizontal turns (c) and draw taut.

Stage 3 Finally, put four frapping turns (d) over the lashing between the spars, draw well taut, and finish with a clove hitch (e).

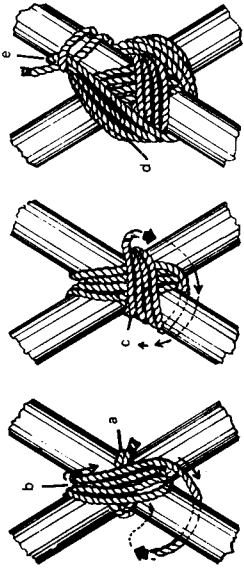

Figure 16. Diagonal Lashing

Round Lashing (Fig. 17)

This is used to lash together two poles which lie parallel to each other.

Insert spacing pieces (a).

Start lashing with a clove hitch (b) round one pole (ends 'married') (c) and continue with 6-8 close turns (d) round both poles, travelling upwards, make two or three frapping turns (e) round the lashing, and on the opposite pole to the beginning of the lashing. Do not remove spacing pieces until the lashing is completed.

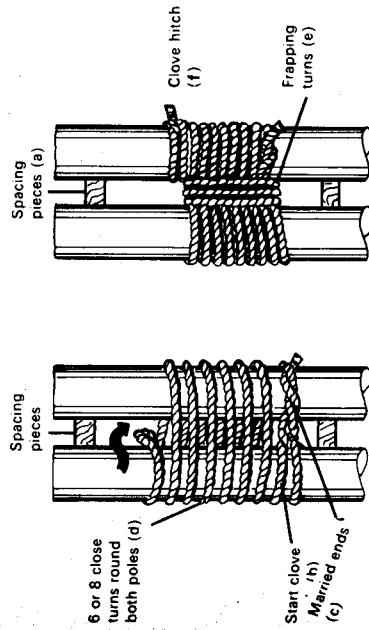

Figure 17. Round Lashing

Figure-of-eight Lashing (Fig. 18)

This is used to lash three parallel poles together, as may be necessary for instance to form a tripod or gin (gyn).

CHAPTER 5 CASUALTY HANDLING

Spacing pieces about 50 mm wide should be inserted (a). Start with a clove hitch (b) round one of the poles, with the ends 'married'. Working upwards all the time from the first clove hitch, continue lashing in figure-of-eight fashion with 6-8 turns (c). Make two to three frapping turns (d) round the lashing, repeat at (e). Finish with a clove hitch (f) on the opposite pole to the beginning of the lashing.

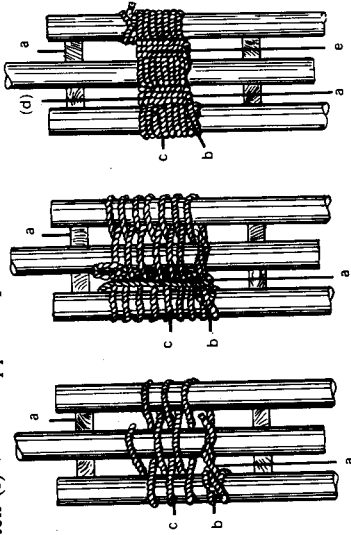

Figure 18. Figure-of-eight Lashing

Making up a 12 m Lashing

It is important that rescue personnel standardise on a set pattern for making up 12 m lashings. If the laid-down procedure is followed then one running end can always be found at the end of the frapping turns. This is particularly important at night.

The rope should be wound around the elbow and hand until about 1 m of rope remains and this is then frapped around the centre of the flattened coil (Fig. 19).

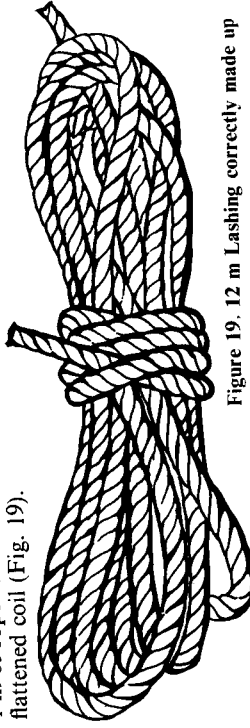

Figure 19. 12 m Lashing correctly made up

There are many occasions where the task is made easier by leaving the lashing coiled and pulling end B, e.g. lashing stretchers, poles, running out guy lines, etc.

First Aid personnel should handle surface casualties but in their absence all casualties must be looked after by Rescue Personnel, whose role, after all, is to save life.

Classification of Casualties

All casualties who require treatment can be classified under three main headings:

- Walking wounded.
- Slightly injured casualties.
- Seriously injured casualties.

Walking Wounded The term is self-explanatory but the following are examples of some types of walking wounded casualties who should NOT be allowed to walk:

- If there is a marked degree of shock.
- If there is the slightest doubt whether there is an internal injury or not.
- Casualties who have bled from an artery, even in a small wound.
- Casualties with head wounds even though they may appear slight.

(e) All cases of poisoning by a nerve or lung irritant gas.

Slightly Injured Casualties are those whose injuries require that they must be evacuated for further treatment, *but* the nature of the injury does not necessitate the use of a stretcher and evacuation can be effected by sitting-case car. A few examples of slightly injured casualties are:

- Cases of serious shock.
- Casualties with an injury to a lower limb, unless it is only a very slight flesh wound.
- Cases who appear to be suffering from gas poisoning or radiation sickness.

Seriously Injured Casualties are those who will probably require hospital treatment. A few examples of seriously injured casualties are:

- All cases of internal hemorrhage; open wounds of the chest (pneumothorax); shattered limbs, grossly lacerated and crushed limbs; wounds of belly; open complicated fractures; fractures of the skull, spine, pelvis and thigh; injuries involving the eye; injuries involving the lower jaw and control of the tongue.

- (b) Cases of severe external hemorrhage and of multiple or extensive burns.
- (c) Cases in which further shock is likely to supervene, as in persons trapped for long periods under debris, or exposed to cold and wet; in fact, all but those with trivial injuries or who are merely shaken, frightened or faint. It must not be forgotten that very small external wounds may be associated with damage beneath the surface.
- (d) All diabetic patients who may be injured or who are suddenly taken ill.

Blanketing a Stretcher

Before an injured person is placed on a stretcher, it should be covered with a blanket so that contact is not made with the canvas bed portion. This adds to comfort, keeps warm, and to a large degree helps immobilise any fractures that may have been sustained. It is

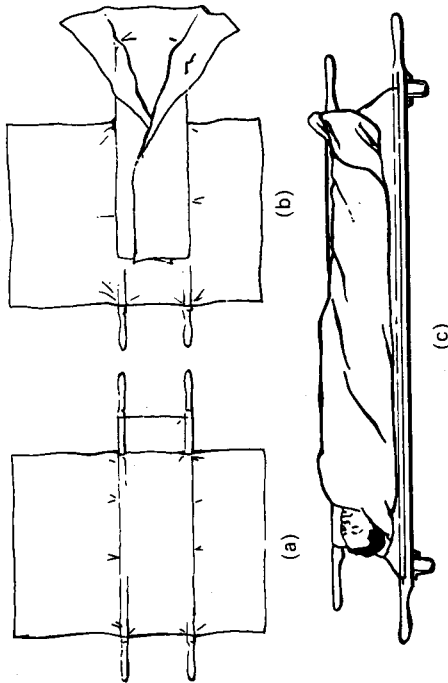

Figure 20. Blanketing a Stretcher (two blankets)

more important to place blankets under than over the casualty. A casualty is better off with two thicknesses of blanket under, and one over, than vice versa. In cool or cold weather, and if the supply of blankets is adequate, it is desirable to use two blankets for each stretcher. However, if the weather is hot one blanket will suffice.

Two Blanket Method

- (i) Lay one open blanket lengthwise across the stretcher level with the head end with about one-quarter of the blanket on one side of the stretcher and one-half on the other, Fig. 20 (a).
- (ii) The second blanket is placed with its centre in the middle of the stretcher and its head about 40 cm from the top. The sides are then folded into the centre and out at the foot, Fig. 20 (b).
- (iii) The casualty is then placed on the stretcher with head level with the top end of the canvas.
- (iv) Blanketing is commenced by taking the centre of the second blanket in between the ankles of the casualty (to prevent chafing) and crossing the end points of this blanket over the legs and tucking them in. These points should be taken as far up towards the knees as possible.
- (v) The short side of the first blanket is taken over the body of the casualty and, if possible, tucked in.
- (vi) The final operation is to tuck in the long side of the first blanket on the opposite side of the stretcher, Fig. 20 (c).

In both steps (v) and (vi) the tips of the blanket should be folded in so as not to obscure the casualty's face.

If operating in a wet or contaminated area, it is advisable to concertina the ends of the first blanket down on to the sides of the stretcher before the second blanket is placed in position. This keeps it clear of the ground and can be easily pulled out when required.

One Blanket Method

In some cases it may be desirable to use only one blanket, e.g. humid weather, lack of blankets, etc.

- (i) Lay one open blanket diagonally down the stretcher with the corner of the blanket in the centre of the top of the stretcher, and about 15 cm overlapping, Fig. 21 (a).
- (ii) Place the casualty on the blanket with head level with the top of the shins.
- (iii) Take the bottom corner of the blanket and tuck it in between the shins.
- (iv) Fold over and tuck in the lower half of the blanket.
- (v) Do likewise with top half, Fig. 21 (b).

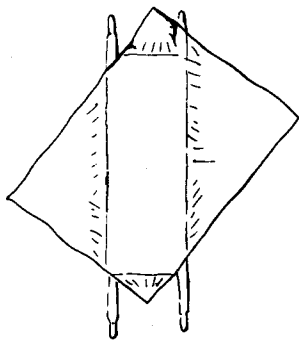

(a)



(b)

Figure 21. Blanketing a Stretcher (one blanket)

Stretcher Lashing

In many cases casualties will have to be firmly secured to the stretcher to enable it to be handled in difficult places. No hard and fast rule can be laid down as to when a casualty should or should not be lashed on. However, the nature of the rescue should in itself provide the answer. If in doubt use the lashing.

The ideal size and length of rope for a stretcher lashing is 12 m of 12 mm rope, i.e. the lashing carried in the Rescue Manpack and by First Aid Parties. Electrical flex or clothes line makes a good substitute and should never be overlooked in an emergency where no equipment is available.

Commence the stretcher lashing by taking a clove hitch around one of the top stretcher handles. From this point take three half hitches around both the casualty and the stretcher, the first in the region of the chest, the second in the vicinity of the wrists and the third hitch just below the knees (Fig. 22).

A round turn is then taken around the feet and three half hitches applied to those already formed on the opposite side of the casualty's body. The lashing is finished as it was started, with a clove hitch on the remaining top stretcher handle.

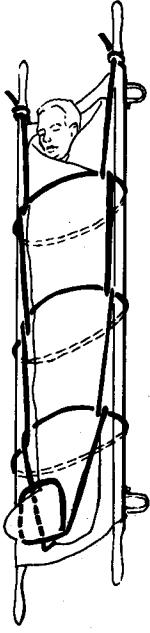

Figure 22. Lashing a Stretcher

It is well to remember that the position of the three securing half hitches can be varied according to the location of the injuries which the casualty has sustained. Bricks or timber placed under the stretcher Ds before lashing commences will enable the rope to be passed under the stretcher more easily.

Moving a Stretcher over Debris

A stretcher should, wherever possible, be carried in the horizontal position. When moving over heavy debris this may prove to be difficult but risks to both casualty and bearers can be reduced to a minimum by adopting the following procedures.

Using six bearers (Fig. 23)—

Moving a heavy casualty over difficult debris conditions for any more than 10 or 15 metres, will almost certainly require six men. The Leader should place three men (including himself) on each side of the stretcher. (*N.B.* The Leader normally takes the position adjacent to the casualty's left shoulder at the commencement of the operation.) On the order 'Prepare to lift' the men stoop and grasp the strings of the stretcher. When all is in readiness, the Leader gives the order 'lift' and the stretcher is raised to waist height. The next order will be 'prepare to pass'. Any member of the team who for any reason at all is not ready should inform the Leader. Good footings on debris are hard to find and care should be taken in this regard. On the command 'pass' the stretcher is passed in the direction it is required to move until such time as it is supported by four men, leaving the Leader and one man spare at the head end. These two men then climb

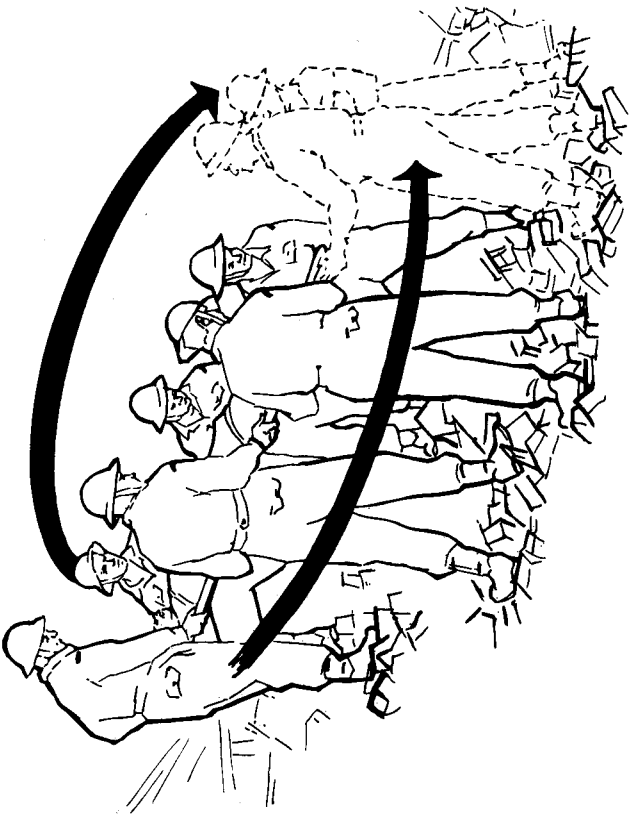

Figure 23. Moving a Stretcher over debris

carefully around the stretcher and take up positions at the foot (see Fig. 23). The process is then repeated until the stretcher arrives on clear, solid ground. It is stressed that this operation of handling a stretcher in difficult conditions calls for a high degree of team work and that the Leader must retain control throughout. He must ensure that while the stretcher is being passed no member of the team is moving on the debris.

Using four bearers:

In this case the operation is carried out in a similar manner, except that where with six bearers there were four men to support the stretcher while two changed their positions to the foot—now using only four men, two must support, whilst the other two move to the foot. It will be found of great assistance to those who are left supporting the stretcher to get their thighs well braced under the strings. Not only

does this relieve the weight on the bearers' arms, but also helps stabilise the whole operation.

Moving a Stretcher in Confined Spaces

In confined spaces, if there is sufficient height and the casualty has been lashed to the stretcher, it may be stood on end and by grasping the strings can be moved around sharp corners. Where the height is insufficient to permit this method being used, as in the case of shelters and basements etc., a compromise between the vertical and horizontal positions is necessary. The casualty should be carried feet first as far as the middle of the right-angled bend when the foot of the stretcher is placed on the ground and the head end lifted as high as the ceiling will permit. The stretcher can be worked around the bend—one bearer easing the foot end and the other the head. Under these conditions the stretcher should not be tipped on its side. To do so would only increase its height and also the difficulty in handling it.

Passing a Stretcher over a Gap

A large gap which has to be negotiated by bearers is probably best overcome by laying an 11 m extension ladder across it and, if possible, placing a decking of boards over the rounds. Shorter gaps, such as in floors etc., can be patched, using timber from the site or possibly the 4 m extension ladder. Still smaller gaps can be reversed by the six- or four-man stretcher parties in a similar way to that described for moving over debris.

Improvised Stretchers

In any disaster of a major nature it is realistic to say that there will not be sufficient stretchers for the number of casualties involved. Fortunately this particular lack of equipment can be compensated for in many ways—only some of which are described.

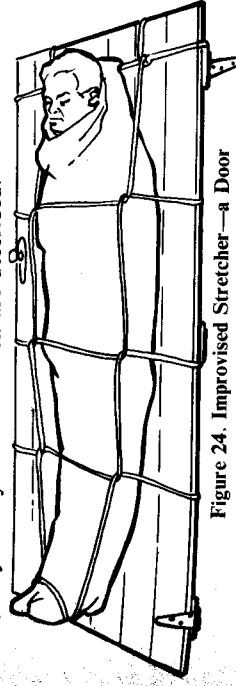

Figure 24. Improvised Stretcher—a Door

Doors (Fig. 24)

These are probably the most readily available improvised stretchers—providing the building has not been completely burnt out they should be in reasonably good supply.

Blanketing is exactly the same as for the conventional stretcher. The lashing, however, requires a slight modification as there are no stretcher handles on which it can be commenced. There are two simple ways in which this can be overcome.

(a) Bore two holes in the head of the door adjacent to the casualty's head and pass the lashing through these to commence and finish it, i.e. thumb knotson the opposite of the door.

(b) Take a round turn around the head of the door securing the running end of the lashing to the standing part with a clove hitch, leaving about 600 mm of running end free.

In both cases the lashing is applied in the normal way, but in case (b) the lashing is made off with a clove hitch on the turn around the top of the door, then taken over the top and clove hitched to the turn on the underneath side. The same thing is done with the tail of the rope left over on the original clove hitch.

N.B. It will be found that by placing the corners of the door on four bricks the lashing can be applied far more easily.

Blankets (Fig. 25)

Blankets make an excellent improvised stretcher and in residential areas should be in fair supply.



Figure 25. Improvised Stretcher—Blanket and Poles.

They are extremely simple to make and in addition to the blanket require only two poles about 2 metres long. Stout broom handles, 12 mm water pipe or timber about 50 mm × 25 mm will do.

Place the blanket flat on the ground and the poles spaces about 600 mm apart longitudinally down the centre. Fold each side of the blanket across each pole and the stretcher is ready. To make it more secure three nails can be used to pin the two top folds together.

Bags (Fig. 26)

Even in suburban houses a number of corn sacks can usually be found in the vicinity of the wood shed. Two of these make a first class stretcher with addition of only two poles.

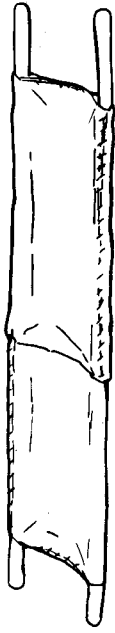

Figure 26. Improvised Stretcher—Sacks and Poles

Cut two slits (cut the stitching) about 8 cm long in the bottom of each bag and simply pass the poles through the slits. Slide the open end of the second bag about 5 cm over the foot of the first and the stretcher is ready for blanketing.

Overcoats (Fig. 27)

Two overcoats with the sleeves turned inside out and poles slid through make quite a good stretcher.



Figure 27. Improvised Stretcher—Overcoats and Poles.

Do up all the buttons on the front of each coat and, if necessary, use nails to close the tail flaps. The coats are placed head to tail and the stretcher used with the fronts of the coats uppermost.

Ladders (Fig. 28)

Where for any reason a very narrow stretcher is needed, such as small window openings, tunnels, etc., half a 4 m extension ladder or any ladder 2-2.5 m long can be used to advantage.

A decking of boards is first placed on the ladder and it is then blanketed in the normal way.

In Fig. 28 a variation of the standard stretcher lashing is shown. It is commenced with a clove hitch on the string above the round nearest the casualty's feet. Two loose round turns are then taken around the ladder and the lashing half hitched to the centre. From

here three half hitches are taken around the body in the usual positions. The lashing is tied off with a clove hitch to a round above the casualty's head.

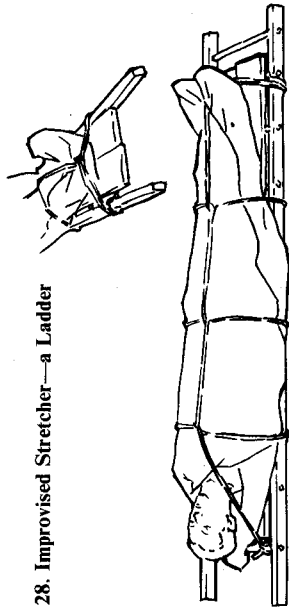

Figure 28. Improvised Stretcher—a Ladder

Bed Frames (Fig. 29)

These make a good stretcher but in most cases are inclined to be a little too wide for easy handling.

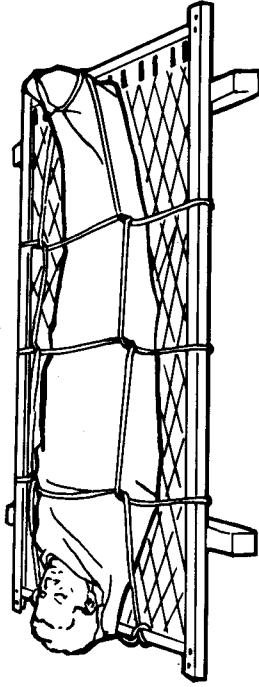

Figure 29. Improvised Stretcher—a Bed Frame

If a lashing is required, it is applied in the normal way—starting and finishing with a clove hitch on the head of the bed frame.

Corrugated Iron

Sheets of 1.8, 2.1 or 2.4 m corrugated iron make good stretchers and in most built-up areas are available in almost unlimited supply. To make the stretcher more rigid the sides of the sheet (about 2 corrugations wide) should be folded underneath.

Chairs (Fig. 30)

Strong kitchen-type chairs—although, strictly speaking, they are not a true stretcher—should never be overlooked in an emergency.

As can be seen in Fig. 30, they provide a comfortable support for the casualty and greatly assist the rescuers in the job of lifting and shifting him.

It must be fully appreciated that the various types of improvised stretchers which have been mentioned by no means complete the list. The range of variations is practically limitless and usually an improvised stretcher can be produced simply and quickly.

Loading a Stretcher

Loading a stretcher is an important part of casualty handling inasmuch as bad loading can seriously aggravate, or increase, the injuries a casualty already has. Care and gentleness must be used at all times.

The Four-man Method (Fig. 31)

If four men are available and there is a reasonable amount of space this is probably the best method.

The steps are as follows:

- (a) Make the stretcher ready and place near the casualty's head or feet.
- (b) Leader details three men to kneel down on one knee on one side of the casualty (casualty lying flat on his back). They all have the knee up closest to the casualty's head.
- (c) Leader kneels near the casualty's buttocks on the opposite side to the three men and eases the casualty over on to his side.

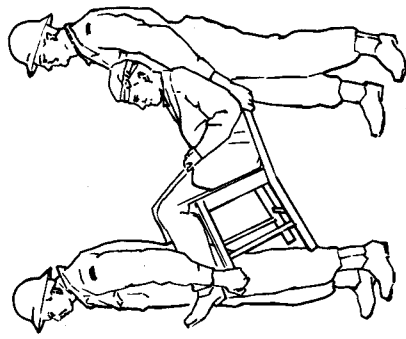

Figure 30. Improvised Stretcher—a Chair

- (d) The three men place their hands and arms underneath the casualty and the Leader lowers the casualty.
- (e) Leader gives the order 'prepare to lift' and if no one dissents follows it with 'lift'—whereupon the three men, assisted by the Leader, lift the casualty up and support him on their knees, Fig. 31 (a).
- (f) The Leader then gets the stretcher and places it on the ground with the top level with the casualty's head, Fig. 31 (b).
- (g) Final orders are 'prepare to lower'—'lower'.
- (h) The three men, assisted by the leader, lower the casualty on to the stretcher.

Blanket Lift (Four Men) (Fig. 32)

This is probably the best method of loading or moving a casualty in a very confined space.

The steps are as follows:

- (a) Make a stretcher ready using one blanket only.
- (b) Fold a blanket lengthwise and lay the folded edge along the side of the casualty (casualty flat on her back).
- (c) Roll the folded edge back to about half the width of the blanket.
- (d) Leader then places two men kneeling down (including himself) on each side of the casualty. The men on the opposite side to the

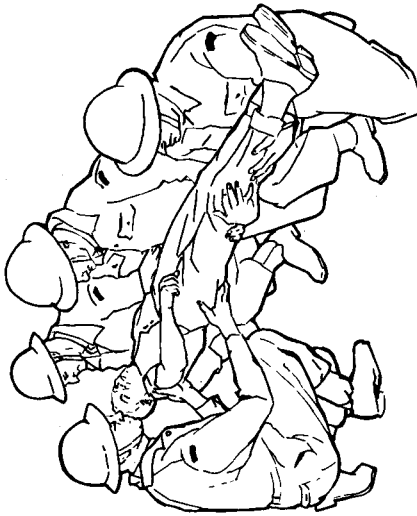

(a)

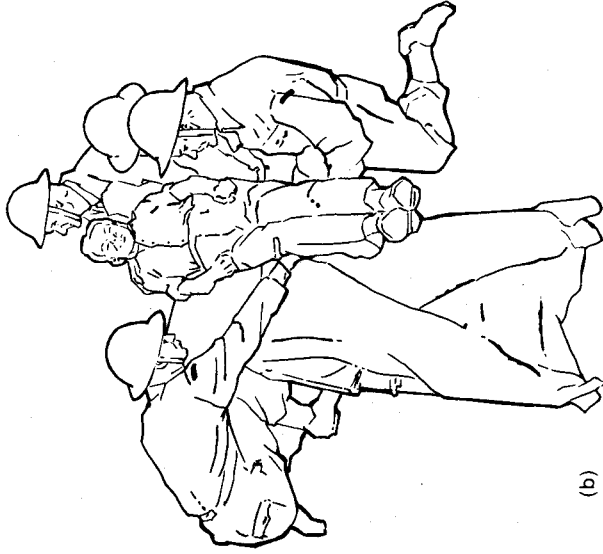

(b)

Figure 31. Four-man Method of Loading a Stretcher

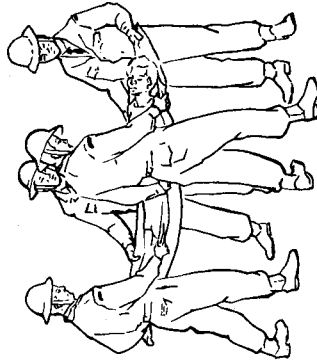

(b)

Figure 32. Blanket Lift Method of Stretcher Loading

blanket ease her up, and then rolled section is pushed well underneath.

- (e) With the rolled up section of the blanket now under the centre of the casualty she is eased over in the opposite direction and the blanket is unrolled. The casualty should now be lying flat on her back with two thicknesses of blanket underneath her.
- (f) The sides of the blanket are then rolled up tightly to provide hand grips for bearers; see Fig. 32 (a).
- (g) When all is ready the Leader gives the order 'prepare to lift', followed by 'lift' and the casualty is taken up to waist height, Fig. 32 (b).
- (h) The orders are then 'side paces to the stretcher move'. When the casualty's head is level with the top of the stretcher the order is given 'prepare to lower'; 'lower'.
- (i) The blanketing is then completed with one blanket, leaving the lifting blanket in position.

Clothing Lift (Three Men) (Fig. 33)

This is a simple method which can be used to advantage when the casualty's injuries are not too severe and time is at premium. The casualty should also be reasonably light.

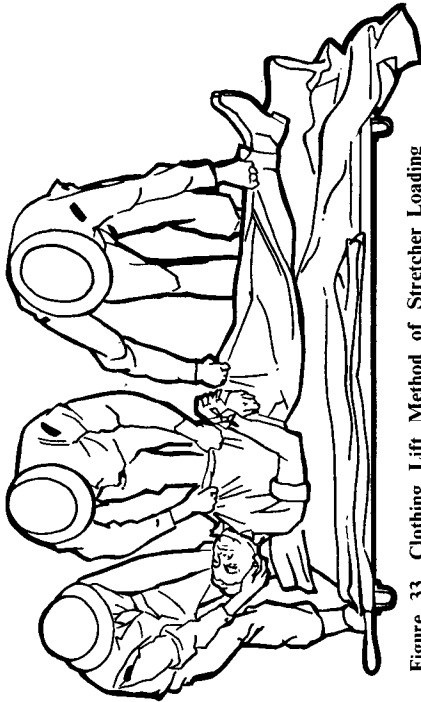

Figure 33. Clothing Lift Method of Stretcher Loading

The steps are as follows:

- (a) Blanket a stretcher and place it close to the side of the casualty.

- (b) Tie the casualty's hands together—a handkerchief is quite adequate.
- (c) Roll the casualty's clothes together along the centre line of his body.
- (d) Three men take up position on the opposite side of the casualty to the stretcher and position their hands as illustrated in Fig. 33.
- (e) The normal commands are given, e.g. 'Prepare to lift', 'lift', etc., and the casualty is gently placed on the stretcher.

Webbing Bands (Five Men) (Fig. 34)

In some cases it may be found necessary to transport a casualty some distance to a place where a stretcher can be loaded. Webbing bands can greatly assist in this operation.

Rescue personnel carry a set of two in their manpack—one long and one short. Usually two or more sets will have to be used. There are many configurations which can be adopted, one of which is illustrated in Fig. 34 (a).

The bands are placed in position by pushing the long steel handle

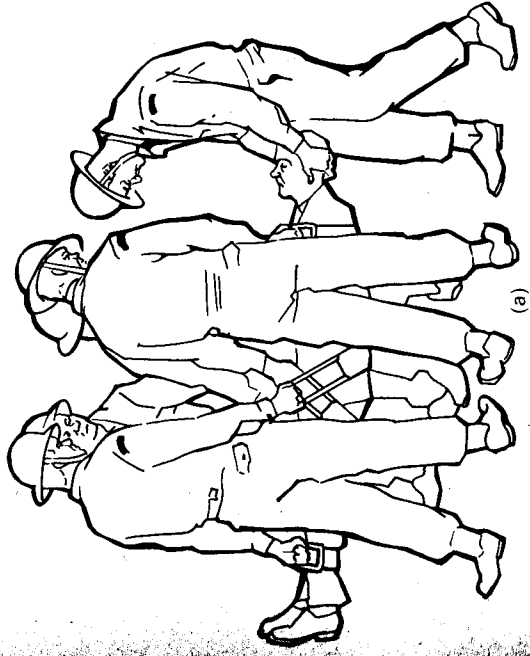
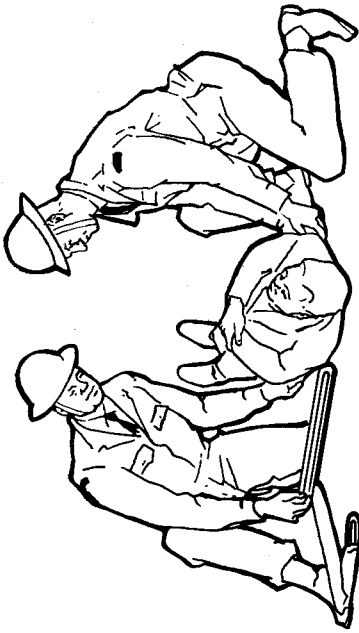

Figure 34 (a). Use of Webbing Bands

under the small of the back and then see-sawing them into the required place, i.e. under the buttocks and shoulders, Fig. 34 (b).



(b)

Figure 34 (b). Inserting a Webbing Band

After the bands have been correctly positioned, the handles of each band are centred in the middle of the casualty and the five men take up the position illustrated in Fig. 34 (a).

The use of webbing bands should never be overlooked when casualties are trapped in tight and difficult situations. They literally provide 'lugs' on the casualty which can be grasped either by rescuers hands or lines attached to them.

Rescue Techniques using no Equipment

This subject is discussed under two headings—

- (a) One man and no equipment.
- (b) Two men and no equipment.

It must be clearly understood that the following techniques are for use in an emergency and that generally speaking seriously injured casualties should, if possible, be placed on a stretcher. However, conditions such as fire or imminent collapse may dictate that removal from the scene is the first priority. In some cases this could even take precedence over the stoppage of bleeding.

(a) Methods Suitable for One Man with no Equipment are—

- One-man human crutch
- Pick-a-back
- Arm lift
- Fireman's crawl
- Fireman's lift
- Removal downstairs method

One-man human crutch For this method to work the casualty must be conscious to a degree and capable of giving the rescuer some assistance.

Fig. 35 clearly indicates how the one man human crutch is applied. However, it is well to note the position of the rescuer's hands—one holding the casualty's wrist and the other taking a firm grip of his clothes at the waist on the far side of his body. The injured side of the casualty should be closest to the rescuer.

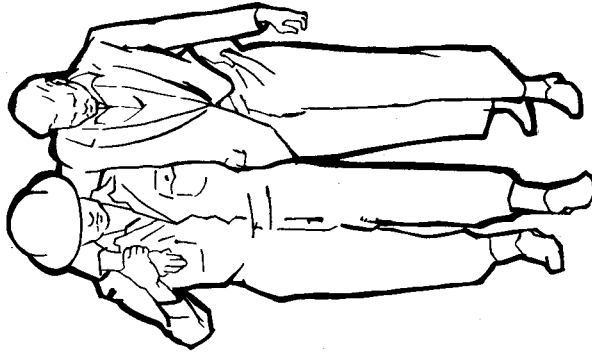

Figure 35. One-man Human Crutch

Pick-a-back This is a well-known method, but there is a pitfall of which the rescuer must beware. When the casualty has been loaded (again he must be conscious to a degree) care should be taken to ensure that he is supported well up on the rescuer's hips and his body literally draped across the rescuer's back, Fig. 36 (a).

Notice in Fig. 36 (b) where the casualty is incorrectly positioned that the rescuer himself is off balance and likely to fall over backwards.

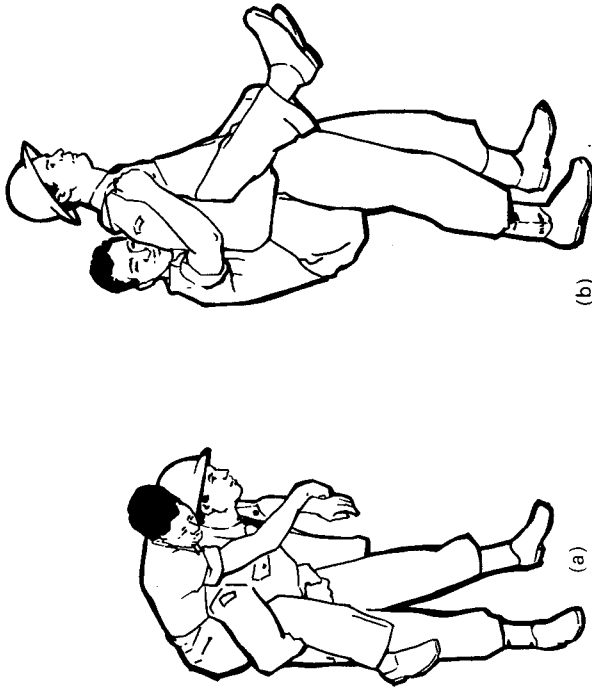

Figure 36. Pick-a-back—Right and Wrong

Arm Lift This is a better alternative to the pick-a-back method, in that the casualty is much better supported, Fig. 37. To prevent injury it is important that the casualty's arms are turned inwards before lifting.

Fireman's crawl This is an invaluable method where a heavy casualty has to be removed from a burning building.

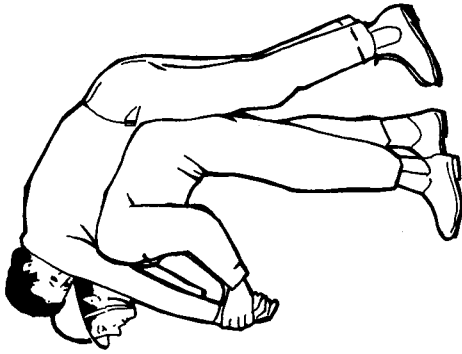

Figure 37. Arm Lift

As can be seen in Fig. 38 (a), both rescuer and casualty have their heads low down where the clearest, coolest air is to be found if the building is on fire. It can also be appreciated that the entire weight of the casualty does not have to be supported by the rescuer. The hands should be crossed over and tied with a handkerchief. A reef knot is most suitable, Fig. 38 (b).

The fireman's crawl method can be varied according to personal preference. An alternative method is for the rescuer to place an arm and shoulder as well as the head through the casualty's arms.



Figure 38 (b). Method of securing Wrists in Fireman's Crawl

(a). Fireman's Crawl

Fireman's lift Where a casualty has to be brought down a ladder or for any reason the rescuer requires one hand free, this technique is ideal. It should not, however, be attempted by a rescuer unless he has been adequately trained in its application.

The eight progressive stages of the fireman's lift are shown in Fig. 39.

Details are as follows:

- (a) and (b) If necessary turn the casualty over onto his front, supporting his head with the knee.
- (c) Force him up into the kneeling position, again using the knee for support.
- (d) Change grip to under casualty's armpits and straighten back.
- (e) With casualty kneeling, rescuer applies a 'bear hug' grip prior to standing casualty up.
- (f) 'Bear hug' grip with casualty in semi-standing position.
- (g) Grasping the casualty's right wrist with his left hand the rescuer prepares to make the final lift.
- (h) If possible all in the one movement the rescuer stoops, ducks his head under the casualty's right arm, gets his shoulder low down (this is most important) into the groin of the casualty, pushes his own right hand between the casualty's legs and lifts. This whole movement wants to be done quickly for the same reason that a weightlifter can lift the greatest weight in what is termed 'the snatch'.
- (i) Once the rescuer is upright he changes hands and grips the casualty's wrist with his right hand. He then has his left hand free and the casualty well supported on his shoulders.

Removal downstairs method As the name implies this technique has been designed to get a heavy casualty downstairs when the rescuer cannot use the pick-a-back or fireman's lift. However, its use need not be restricted to staircases.

With the casualty lying flat on his back the first step is to tie his wrists together using a handkerchief. Next the rescuer comes to his head and lifts him into the sitting position. He then reaches through under the casualty's arms and grasps his wrists. He is then in a position to drag the casualty backwards and if a staircase has to be negotiated a large measure of support can be given to the casualty's trunk by the

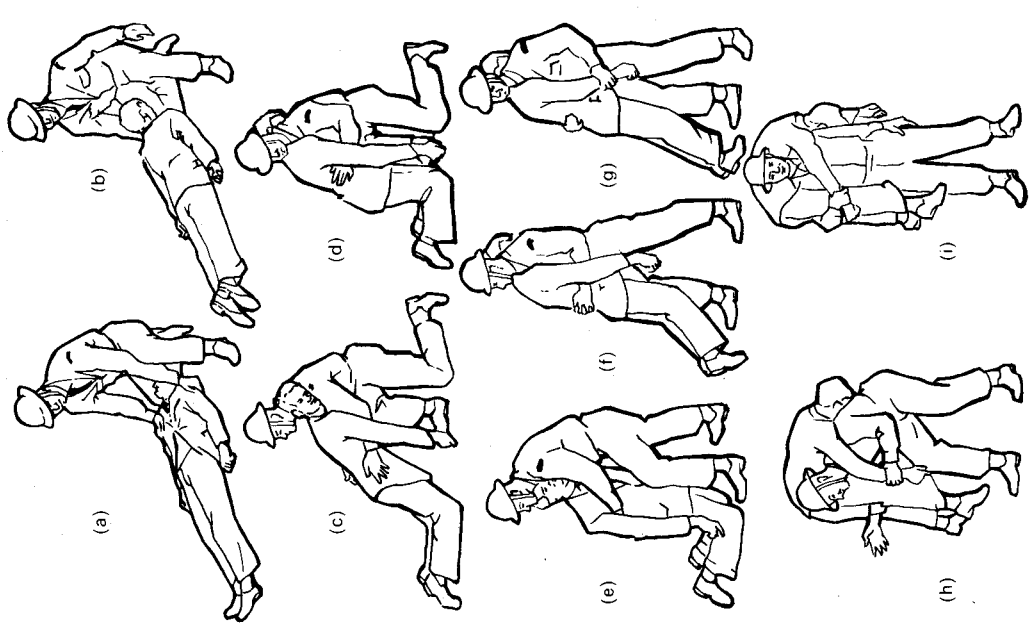

Figure 39. Fireman's Lift

rescuer using his knee to ease him over each successive stair (Fig. 40). It is well to remember that the strongest part of any staircase is close in to the wall.

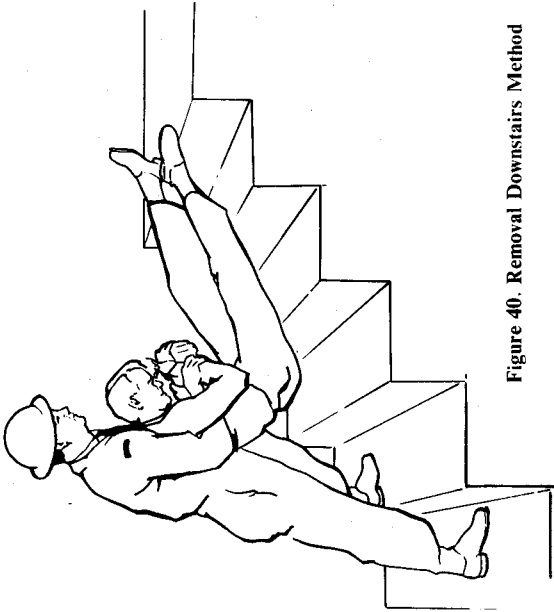

Figure 40. Removal Downstairs Method

Using two men and no equipment, the same principles apply as with the one-man techniques, but naturally the effort required is halved.

(b) *Methods Suitable for Two Men and No Equipment are*

- Two-man human crutch
- Two-handed seat
- Three-handed seat
- Four-handed seat
- Fore and aft method

Two-man human crutch As can be seen from the illustration (Fig. 41) the method is similar to the one-man human crutch except that the casualty is supported on both sides. The arms of the rescuers cross over on the casualty's back and grasp the clothing on the opposite sides of his body.

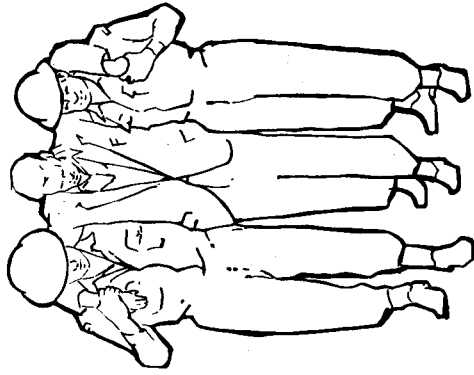
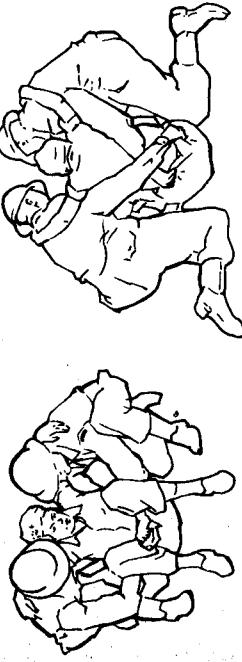

Figure 41. Two-man Human Crutch

Two-handed seat This is a very good way of dealing with a casualty who has to be carried.

As in Fig. 42 (a) rescuers kneel on either side of the casualty, get him into the sitting position, place their right and left arms under his knees and link up with the monkey or hand to wrist grip. Their free arms are then crossed over the casualty's back where they get a firm grip on his clothing, Fig. 42 (b). The rescuer on the casualty's left should be the leader and give the orders. In this case 'prepare to lift', 'lift' and when the casualty has to be lowered, 'prepare to lower', 'lower'.



(a) Figure 42. Two-handed Seat (b)

Three-handed seat This method gives the casualty good support and is reasonably comfortable for the rescuers. It has the added advantage that the two-man team has a spare hand for steadying.

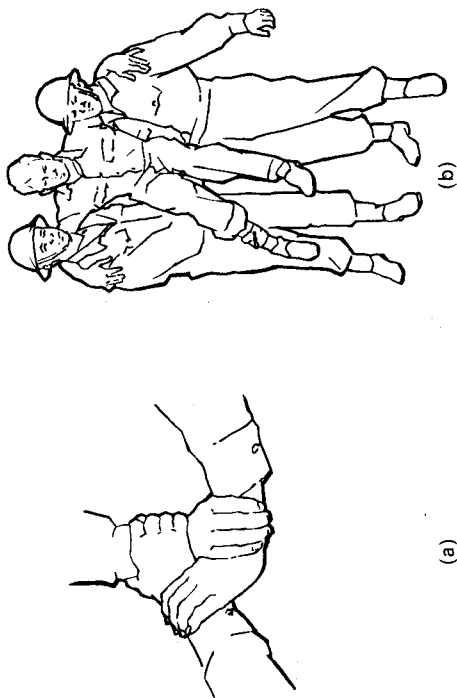

Figure 43. Three-handed Seat

One rescuer grasps his left wrist with his right hand and the second man places his hand and wrist as shown in Fig. 43 (a). This forms the seat. If the casualty is capable of standing for a few seconds he can be loaded by placing the seat under his buttocks, if not the rescuers hands must be passed under the casualty's knees first and then joined up. In either case the result should be as in Fig. 43 (b). Orders are the same as for the two-handed seat.

Four-handed seat This is a well-known method where each rescuer grasps his own left wrist and the hands are joined up as in Fig. 44 (a).

This provides a comfortable ride for the casualty and places a minimum of strain on the rescuers. However, as can be seen in Fig. 44 (b) the casualty must be sufficiently conscious to hold on. The orders given are the same as for the two-handed seat.

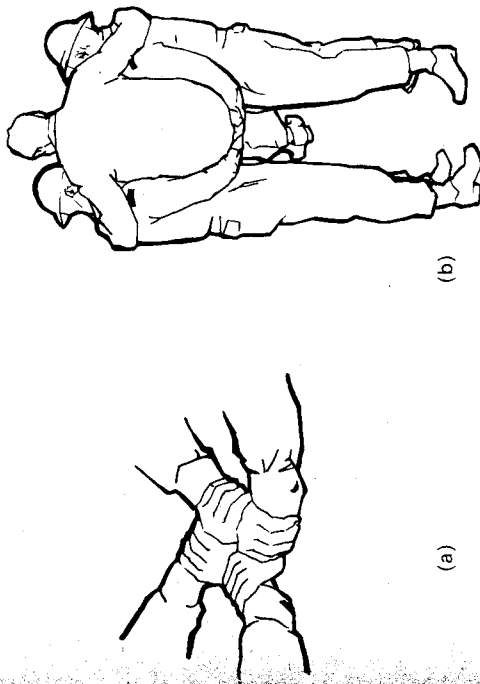

Figure 44. Four-handed Seat

The fore and aft method This is perhaps the most suitable way two rescuers can handle an unconscious casualty

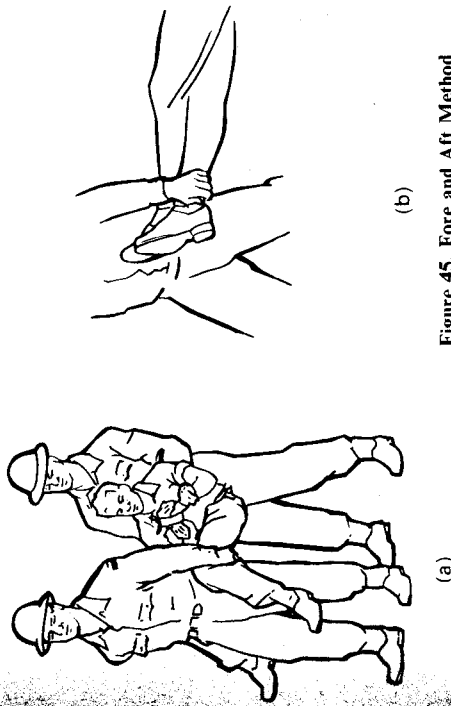

Figure 45. Fore and Aft Method

CHAPTER 6 RESCUE FROM HEIGHTS

The casualty is prepared in the same way as for the removal down-stairs method, i.e. his wrists are tied with a handkerchief. The Leader stoops at the rear of the casualty, gripping the casualty's wrists as the second rescuer stoops between the casualty's legs, grasping them underneath the knees. The appropriate orders are given and the casualty is lifted to the carrying position, (Fig. 45 (a)).

Should the casualty have a leg injury the effects of this can be minimised by the front rescuer crossing the casualty's legs over then carrying them at his side as in Fig. 45 (b). The advantage with this method is that the rescuer supporting the casualty's feet has a free hand with which to open doors, clear debris, etc.

It is again stressed that the foregoing one- and two-man rescue techniques are generally confined to emergencies where removal from the scene is the first priority.

In any sort of major disaster it is safe to say that large numbers of people and casualties will be trapped in the upper floors of buildings, if the staircases are destroyed or blocked off by debris. There are many ways of dealing with this situation but in this chapter remarks are confined to dealing with casualties. It is well to remember that all persons who are trapped are not casualties; a lot will be capable of helping themselves to a large degree.

Chair Knot

The tying of this knot is described in Chapter 4. In rescue from heights it can be used wherever a casualty does not have to be placed on a stretcher or in case of emergency can be used as a last resort

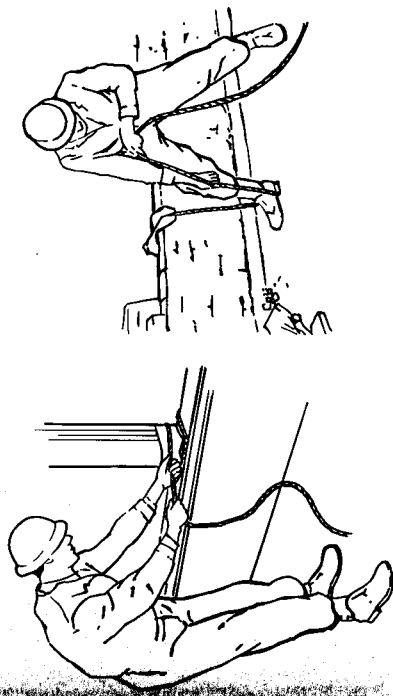

Figure 46 (a) and (b). Controlling a Lowering Rope

to get any casualty down quickly. Working alone it is practically impossible for one rescuer to lower a casualty in the normal hand-over-hand method. If the job has to be done without assistance, the rescuer should if possible take a round turn round a solid object close to the point of lowering, Fig. 46 (a). If an object is not available the foot instep method can be used, Fig. 46 (b). In both cases a chafing piece should be used in the position indicated.

It is stressed that one man lowering a casualty in a chair knot should only be used as a last resort where possibly fire and lack of manpower dictates that it should be attempted.

Two-point Vertical Suspension (Fig. 47)

Of the various methods of getting a stretcher down from a height, this one is undoubtedly the simplest.

The casualty is blanketed and lashed to a stretcher in the normal way with the addition of a bandage tied across the forehead to prevent the head flopping forward if the casualty is unconscious. If the casualty has only to come down one storey, a 12 m lashing is middled and the ends tied with a bowline to the top two stretcher Ds. The same procedure is used for the foot of the stretcher and the lashing passed out to the two men on the ground. The two rescuers then ease the stretcher over the edge of the wall, handling it by the strings until such time as they come to the guide lines with which they lower away hand over hand. The two men on the ground steer the stretcher clear of any obstructions and walking in on the guide lines support the stretcher on either side as it comes down. This technique can be used equally well inside the building, using a hole found or cut in the floor. If a hole has to be cut a square about 750 mm is adequate. If possible do not cut through floor joists as it takes longer and weakens the whole structure. Four men is the ideal team for the job although two men can do it if there is adequate landing space for the stretcher on the floor below.

Four-point Horizontal Suspension (Fig. 48)

Where it is essential for medical reasons to keep the casualty horizontal the four-point horizontal suspension can be used.

The stretcher is rigged in the same way as for the two-point suspension except that it is advisable to use four separate lashings—one for each D on the stretcher. A suitable hole must be found or cut in the floor, about 2.3 m x 750 mm is required, and the stretcher is then manned and lowered as shown in Fig. 48. The men on the far side pull the stretcher across until it is located over the centre of the hole.

Manpower requirement above is four unless the casualty is a light one in which case two men positioned at the head and foot of the stretcher can do the job—each manning two ropes. If no suitable landing is available for the stretcher below two men will be required there.

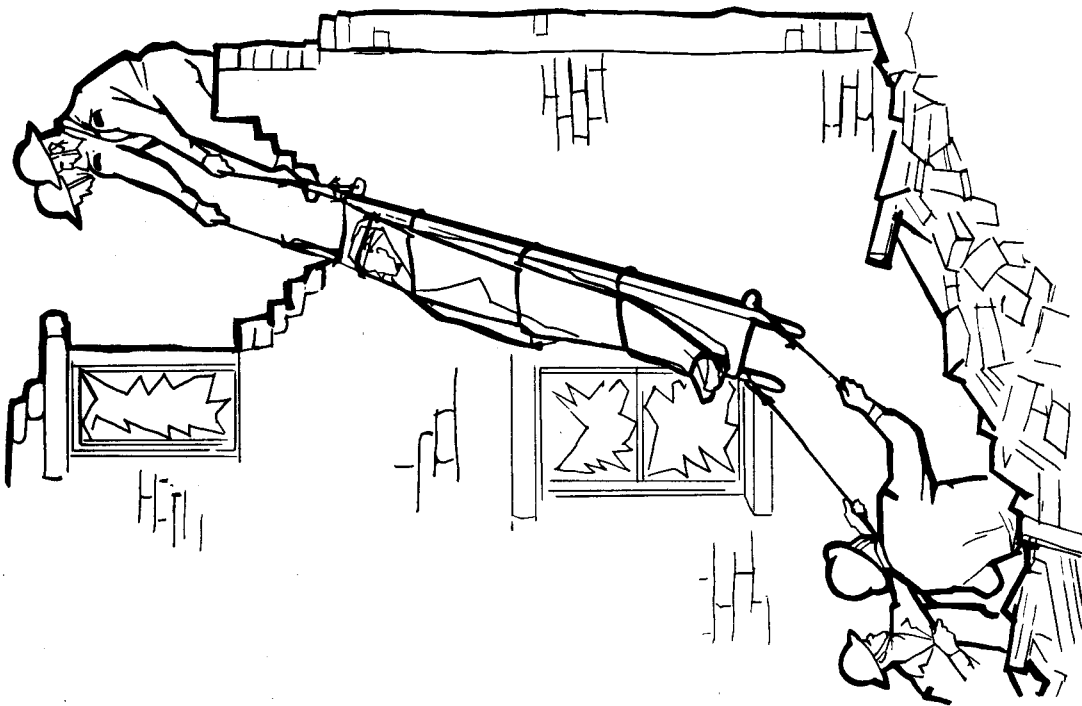

Figure 47. Two-point Vertical Suspension—Four Men

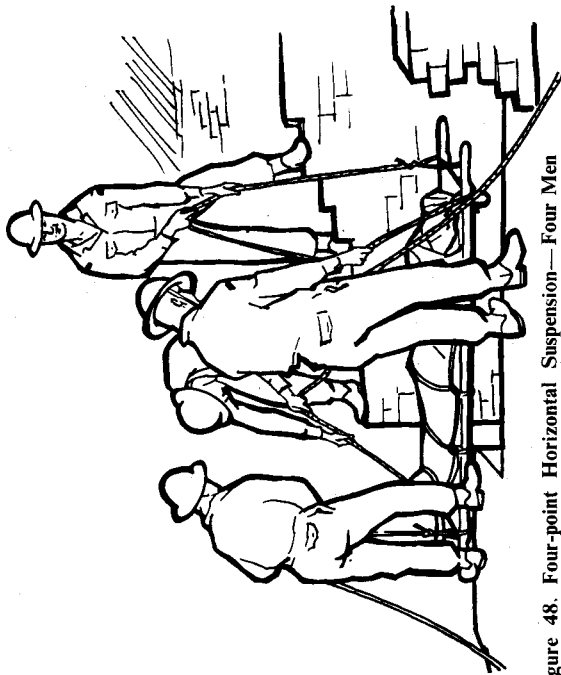

Figure 48. Four-point Horizontal Suspension—Four Men Ladder Slide (Fig. 49)

This is an extremely sound method of getting a casualty down from the first or second floor.

The casualty is blanketed and lashed to a stretcher and two guide lines secured to the top Ds with bowlines. When ready, the ladder is placed in position by the three men on the ground with one man (No. 4) footing it and one man (No. 5) acting as a human prop. The Leader, No. 1, climbs the ladder taking with him two pick handles or equivalent sized pieces of wood—one of which he passes into the building. The foot of the stretcher is passed out on to the ladder and No. 1 places a pick handle through the two bottom stretcher Ds. The stretcher is then moved down the ladder until such time as the head end passes clear of the opening. Nos. 2 and 3 place the second pick handle through the top stretcher Ds and secure it by taking a round turn around the pick handle and a half hitch about the handle of the stretcher on each side (insert, Fig. 49). The stretcher is slid down the ladder. Nos. 4 and 5 assisting with its carriage when No. 1 is on the ground.

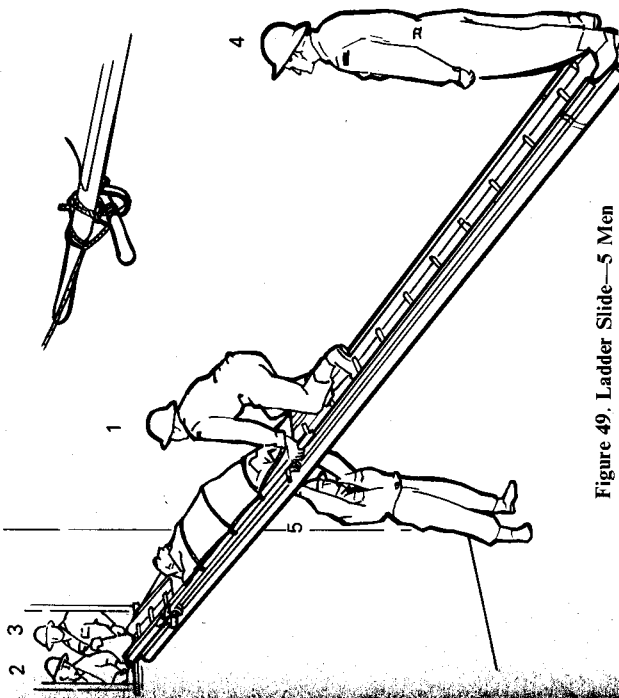

Figure 49. Ladder Slide—5 Men

Ladder Hinge (Fig. 50)

This is a comparatively simple and quick method of getting a casualty down from an upper floor when it is desirable to keep the stretcher horizontal or the building is so unstable that it cannot be used to assist in the operation.

The casualty is blanketed and lashed to a stretcher in the normal way and the ladder placed vertically against the wall in front of the opening where the stretcher is to come out. No. 2 supports the head of the stretcher while No. 3 lashes the foot of the stretcher to the ladder about 25 cm above the window opening (Fig. 50 insert). The lashing is applied with a 5 m sash cord lashing as follows. Start with a bowline tied through the D on one side of the stretcher. Next a half hitch is taken around the ladder string and the side of the stretcher drawn up until it is about 25 cm clear of the sill. Six to eight round turns are taken around the rung, half hitched to the string on the opposite

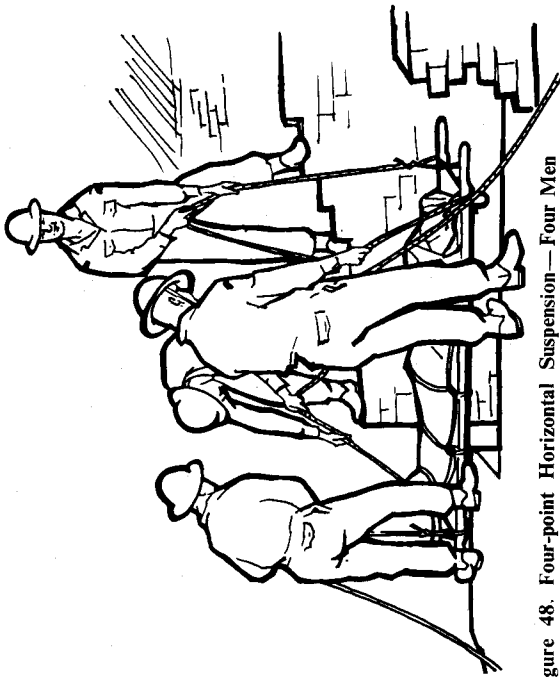

Figure 48. Four-point Horizontal Suspension—Four Men Ladder Slide (Fig. 49)

This is an extremely sound method of getting a casualty down from the first or second floor.

The casualty is blanketed and lashed to a stretcher and two guide lines secured to the top Ds with bowlines. When ready, the ladder is placed in position by the three men on the ground with one man (No. 4) footing it and one man (No. 5) acting as a human prop. The Leader, No. 1, climbs the ladder taking with him two pick handles or equivalent sized pieces of wood—one of which he passes into the building. The foot of the stretcher is passed out on to the ladder and No. 1 places a pick handle through the two bottom stretcher Ds. The stretcher is then moved down the ladder until such time as the head end passes clear of the opening. Nos. 2 and 3 place the second pick handle through the top stretcher Ds and secure it by taking a round turn around the pick handle and a half hitch about the handle of the stretcher on each side (insert, Fig. 49). The stretcher is slid down the ladder, Nos. 4 and 5 assisting with its carriage when No. 1 is on the ground.

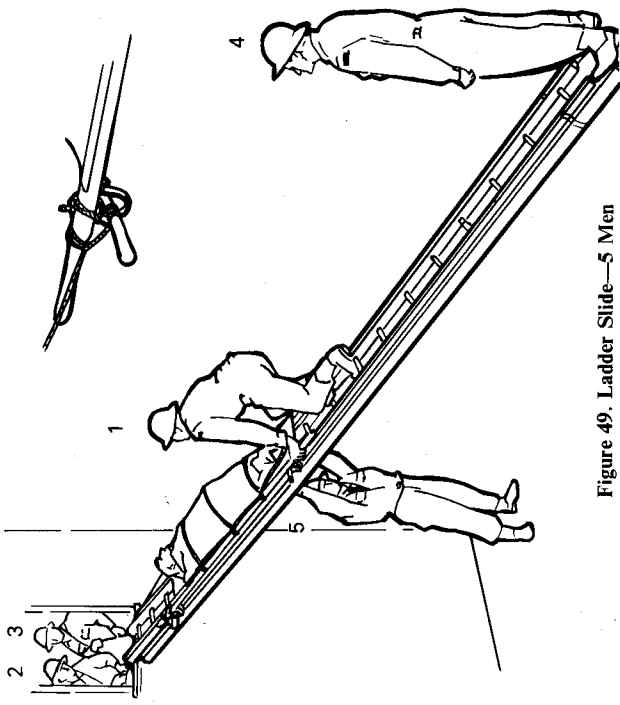

Figure 49. Ladder Slide—5 Men

Ladder Hinge (Fig. 50)

This is a comparatively simple and quick method of getting a casualty down from an upper floor when it is desirable to keep the stretcher horizontal or the building is so unstable that it cannot be used to assist in the operation.

The casualty is blanketed and lashed to a stretcher in the normal way and the ladder placed vertically against the wall in front of the opening where the stretcher is to come out. No. 2 supports the head of the stretcher while No. 3 lashes the foot of the stretcher to the ladder about 25 cm above the window opening (Fig. 50 insert). The lashing is applied with a 5 m sash cord lashing as follows. Start with a bowline tied through the D on one side of the stretcher. Next a half hitch is taken around the ladder string and the side of the stretcher drawn up until it is about 25 cm clear of the sill. Six to eight round turns are taken around the rung, half hitched to the string on the opposite

side of the ladder and finally secured to the other D on the foot of the stretcher using a round turn and two half hitches. This hitch is used so that the stretcher may be adjusted for lateral balance. Two 12 m lashings are then tied to the top stretcher Ds (bowlines) for use as guide lines. When all is secure the word is passed to the Leader and he gives the order 'lower away gently' and the stretcher is passed out the window by Nos. 4 and 5, who eventually support the head end of the stretcher by the guide lines (Fig. 50). Nos. 2 and 3 remain close to where the ladder has been footed and ensure no side sway develops while the leader walks backwards hand over hand along each rung and controlling the speed of the whole operation. The stretcher should finally come to rest on top of the ladder flat on the ground.

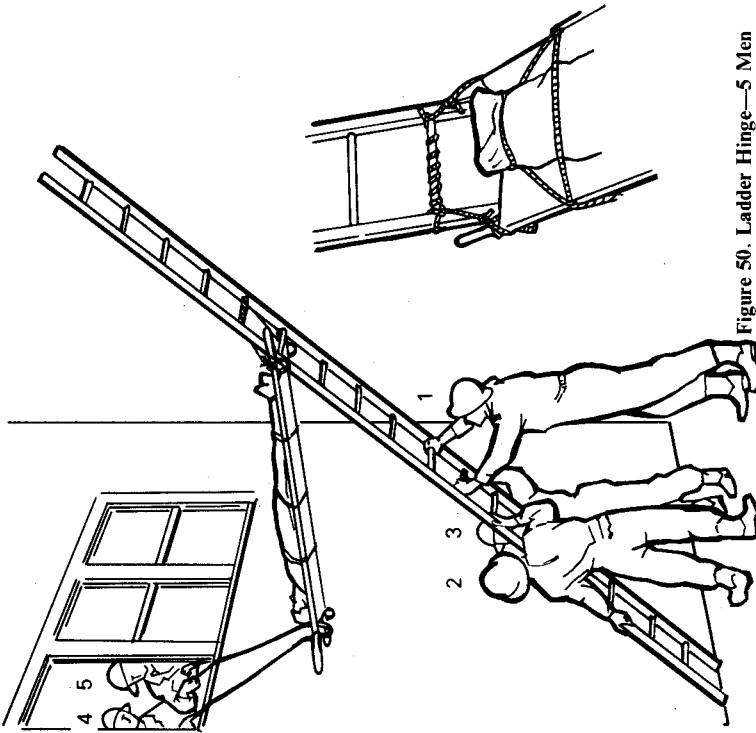

Figure 50. Ladder Hinge—5 Men

Leaning Ladder (Fig. 51 (b))

This a technique for getting casualties down from upper floors of a building in the horizontal position.

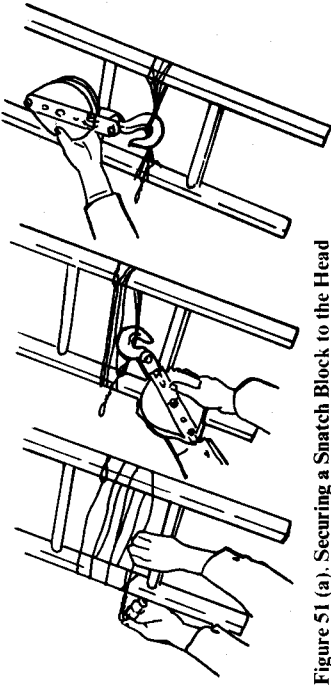

Figure 51 (a). Securing a Snatch Block to the Head of a Ladder

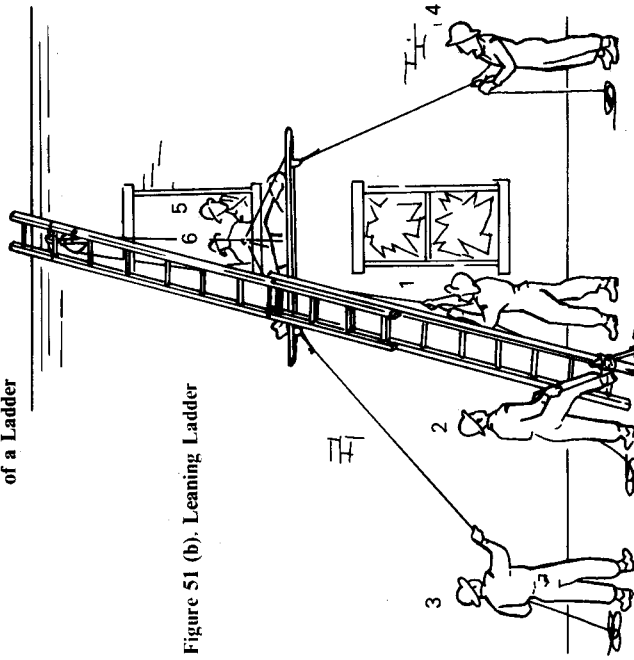

Figure 51 (b). Leaning Ladder

A snatch block is attached to the head of a ladder using a wire bond as illustrated in Fig. 51 (a). Start by passing the bond through its own eye and finish up on the opposite side of the ladder with a clove hitch. Insert the hook of the block on the lower turns and tip it over, producing the figure of eight effect shown. Do not make the bond turn too tight or it will be found that the block cannot be tipped over.

A 17 or 24 mm lowering rope is then rove through the block and temporarily tied to the bottom of the ladder. The ladder is raised to the vertical and extended until the snatch block is at least 3 m higher than the bottom of the opening from which the casualty is to come out.

The men up top (Nos. 5 and 6) should by this time have the casualty blanketed and lashed to a stretcher and two guide lines secured to the outside stretcher Ds. These lines are thrown down to the men on the ground (Nos. 3 and 4) before the lowering operation starts. A chair knot is fitted to the stretcher and the lowering rope attached to it by means of a round turn and two half hitches. No. 2 takes the other end of the lowering rope under the bottom rung of the ladder and stands braced ready to haul in or lower away as directed by the Leader. The Leader places himself under the ladder and assists No. 2 with the lowering rope and gives the appropriate orders as and when required. It will be noted that should the Leader have, for any reason, to leave his position he can do so with the assurance that No. 2 will be able to support the weight of the stretcher.

If a narrow window opening is being used initially the stretcher will have to be lifted by Nos. 5 and 6 and pushed out at an angle between the window and the ladder, then turned parallel to the wall by Nos. 3 and 4 on the guide lines. The operation is completed by the Leader and No. 2 carefully lowering the stretcher to the ground.

The Ladder Derrick (Fig. 52 (b))

This technique has particular application where the structure from which the casualty has to be removed is so unstable that it cannot be used in any way to assist the operation. In this case the rig is self-supporting and does not depend on support from the building in any way.

The first step in erecting the ladder derrick is to rig the head of the ladder as in Fig. 52 (a). The snatch block is attached as for the leaning

Figure 52. (a) Ladder Derrick Ladder Head Rig
(b) The Ladder Derrick

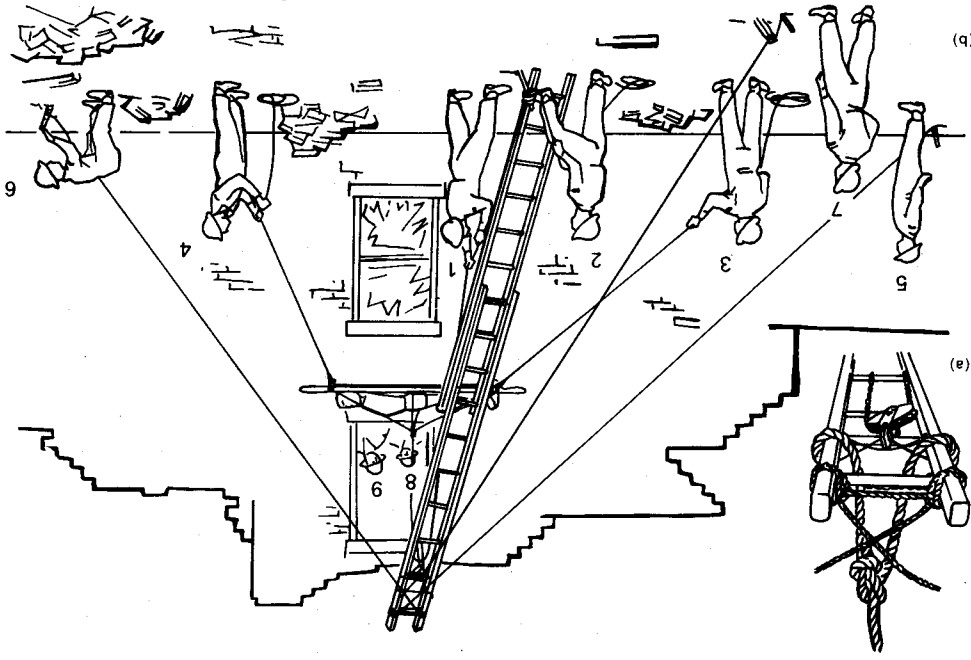

ladder; then the 24 mm rope secured between the top two rounds and tied back on its standing part with a bowline. This is used as a back guy and carries the main load. Next, a 12 m lashing is middled and clove hitched to the top of the ladder strings. The ends are crossed over and have an additional 12 m lashing bent on to each to form the side guys. It is often a good plan to attach another 12 m lashing to the centre of the top round to act as a front guy. This greatly assists in erecting the ladder when the time comes. The 16 mm rope is rove through the snatch block and is used for lowering the stretcher.

Three sets of picket holdfasts are then driven to support the back and side guys. In good holding ground one to one is usually sufficient for the back guy and single pickets for the two side guys. If possible, the side guys should be located in front of the point where the ladder is to be footed. Holdfasts should always be at least double the height of the ladder out from its foot.

The ladder is now ready to be erected and under the control of the Leader—Nos. 3 and 4 under run the ladder while No. 2 foots it. All guys should be manned and if a front guy is attached Nos. 8 and 9 can assist in getting the ladder into the vertical position. Once there, it is extended to the required height and, after being squared up by the Leader, the guys made fast with a round turn and two half hitches. Remember the guys stretch when under load and may have to be adjusted from time to time. If necessary, the foot of the ladder should be dug in or picketed.

From here onwards the operation is the same as for the leaning ladder method with the exception of the personnel numbering in the two figures. At all times while the rig is under load the holdfasts should be carefully watched to ensure they show no signs of pulling out. Nine is the ideal number of men required for the ladder derrick, although seven can be used if the two side guys are left unmanned. If this is the case No. 7, the back guy man, should be detailed to watch the three sets of holdfasts.

Flying Fox (Fig. 53 (a), (b) and (c))

This is a relatively simple method of getting casualties down from a height in the horizontal position, using basically a 16 mm or 24 mm rope and a snatch block. The building, however, must be capable of standing the additional strain placed upon it. It is an important rescue technique for crossing flooded rivers etc.

64

The rope on which the snatch block runs (16 mm or 24 mm) is first secured to a strong point well inside and above the floor from which the casualty is to be lowered. This detail is important otherwise it will be impossible to place the snatch block over the rope once it has been attached to the stretcher or if anchored too low down there will be insufficient clearance between the rope and bottom of the opening. The other end of the rope is secured to a holdfast on the ground at right angles to the face of the building. Before the rope is made off it should be tightened, either by three or four men hauling on it or by use of a Tirfor. When taut, secure with a round turn and two half hitches.

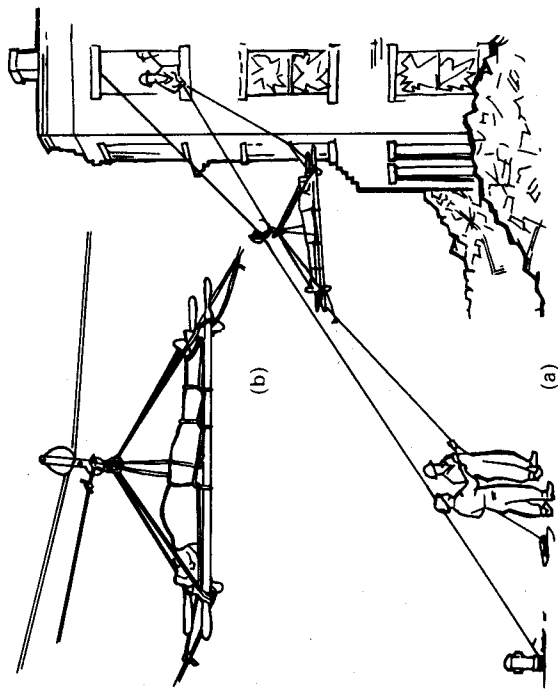

Figure 53 (a) and (b). The Flying Fox.

The stretcher is blanketed and lashed in the normal way and chair knot fitted and tested for balance. Guide-cum-life lines are secured to the head and foot of the stretcher by passing the end of a 12 m lashing through the two Ds and tying off with a bowline. Ensure sufficient 12 m lashings are bent together at the head end, especially, to enable the stretcher to reach the ground. An additional 12 m lashing,

65

or lashings, should be attached to the snatch block just above the hook so it can be hauled up, if necessary, after the first casualty has been lowered.

Although these lines attached to the stretcher and snatch block are principally for lowering and guiding purposes it must be remembered they could be used as life lines should anything happen to the chair knot, snatch block or main rope. Consequently the men up top and down below must be ready at all times to support the sudden extra load should a breakage occur.

When all is in readiness the hook of the snatch block is slipped under the middle rope in the top of the chair knot (Fig. 53 (c)) and the hook moused.

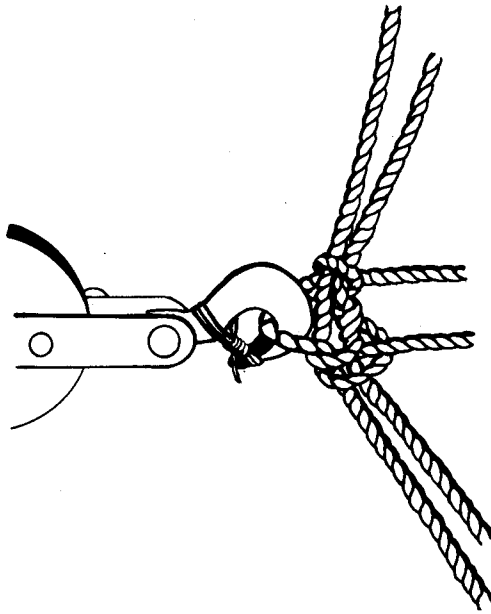

Figure 53 (c). Method of Securing Snatch Lock to Chair Knot

The line on the foot of the stretcher is thrown down to the men on the ground, the stretcher lifted by the men up top and the snatch block slipped over the lowering rope and the gate secured with the pin. The casualty is then carefully lowered by paying out and taking in on the guide lines. This must always be done by the hand over hand method—never let the rope run through the hands.

If more than one casualty has to be brought down the chair knot can be attached to another stretcher on which is placed blankets etc., and the lot hauled up with the line made fast to the snatch block. In this respect the flying fox is ideal for moving numbers of casualties who may be trapped in the upper floors of buildings.

The Jib (Fig. 54)

Basically, the jib consists of a pole projecting about 1 metre (horizontal distance) over the side of a building, with a snatch block attached to the end, through which is rove a lowering rope. It is a quick method of lowering stretchers in a horizontal position.

The timber used for the jib must be strong enough to allow for the 1 metre projection to bear all the weight. A couple of rafters bound together should be quite adequate. A 6 m pole from the Rescue vehicle is ideal.

Before pushing the jib pole out the snatch block must be secured. To do this middle a 5 m sash cord lashing and clove hitch the middle of the lashing to the hook of the block. Then cross the two running ends over the top of the pole about 30 centimetres back from the end. Take two or three cross-over turns over the pole and through the hook, then frap the centre of the lashing again using the cross-over turns and finish off with a reef knot. Reeve off the lowering rope and tie a thumb knot 2 or 2.5 m back from the running end to prevent it running back through the block.

Note: Ensure that the lowering rope comes over the top of the wall and not through the opening where the casualty is going out when reeving it off.

The pole must then be firmly lashed in position, making sure that the snatch block is in the centre of the opening and about 1 m out from the wall. It is important that the pole be lashed as near to the point where it passes over the wall as possible, as side strains will often be set up during the lowering operation. The other end of the pole must also be lashed down to a solid part of the building. Remember this end of the pole will tend to lift—this point must be borne in mind when selecting an anchorage. It is not necessary that the pole should be at right angles to the wall or that it should be in the horizontal plane, e.g. the inside end of the pole could be tailed down to a floor joist if it were solid.

The casualty is blanketed and lashed in the usual way and a chair knot applied. Two guide lines are bowlined to the outside stretcher Ds.

CHAPTER 7 THE REMOTE BREATHING APPARATUS

The Fire Services are trained and equipped to undertake the recovery of casualties or trapped persons from contaminated buildings or basements in peacetime disasters.

In the event of war, and particularly in the case of nuclear war, these services will be forced to concentrate on their essential task of controlling and containing the overall fire situation and, consequently, may not be available for the task of recovery.

Therefore it is essential that Heavy Rescue Parties be equipped with some form of Breathing Apparatus so that they can attempt the extrication of people trapped in contaminated areas.

The R.B.A. is a simple but effective piece of equipment enabling a rescuer to cope with areas in which there may be concentrations of industrial, coal or war gases in addition to areas deficient of oxygen or containing concentrations of irritant smoke.

The equipment consists of (Fig. 55):

(a) A facepiece with a long flexible connecting tube coupled to a 12 m length of 25 mm internal diameter wire bound hose.

(b) A waist belt.

(c) A signalling line for attaching to the wearer.

This equipment calls for a team of three for its operation:

No. 1—the wearer and rescuer;

No. 2—who holds the signalling line;

No. 3—who pays out the coil of hose, and listens for any orders that No. 1 may pass via the breathing hose.

If possible, a fourth man should be standing by with a second set of R.B.A. equipment at the ready, should the rescuer require assistance. Even if the man is not available *the second set of equipment must be kept close handy.*

During the rescue operation, No. 2 keeps as close to No. 1 as practicable and assists with the paying out and hauling of the hose. He

69

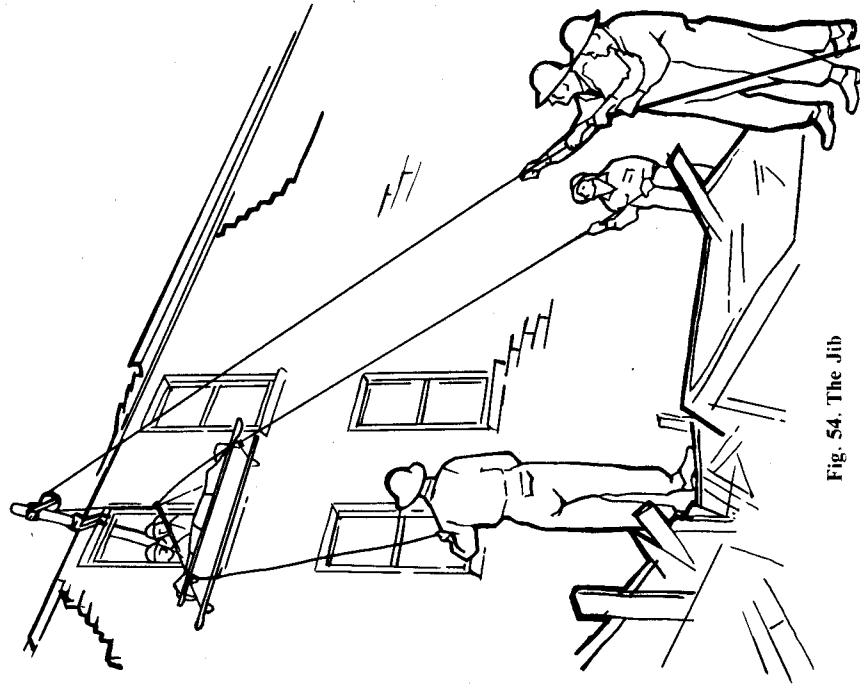

Fig. 54. The Jib

and thrown down to the men on the ground. The lifting rope is secured to the chair knot with a round turn and two half hitches.

At least two, preferably three, men will be required on the lowering rope under the control of the Leader. When all is ready the weight is taken on the lowering rope and the two men up top ease the casualty out through the opening, feet first. As soon as possible the men on the guide lines swing the stretcher around parallel to the wall and lowering commences. If necessary, the guide line men can pull the stretcher out to a clear landing space as it comes down. They should walk in on their lines so as to be ready to grasp the stretcher when it comes in reach.

68

normally shouts instructions to No. 1 and awaits his signals by pulls on the signalling line. No. 3 is responsible for paying out the hose and seeing that its end is clear of the ground and in fresh air.

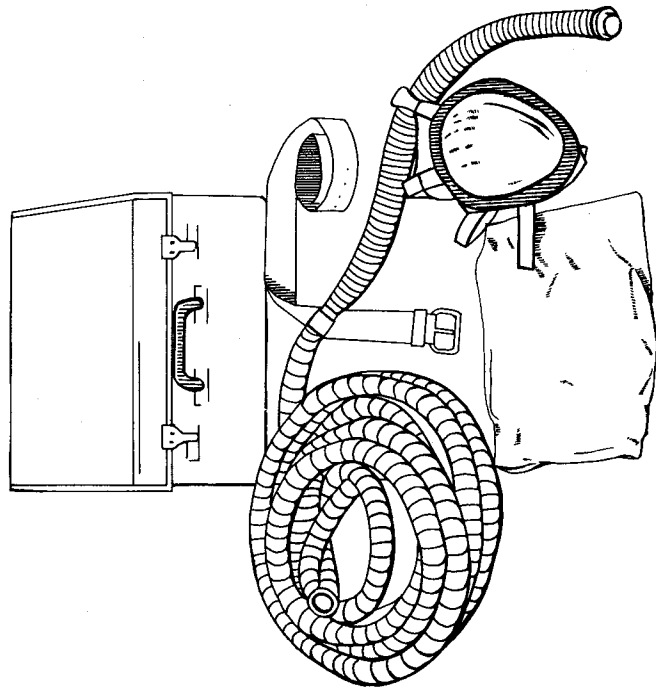

Figure 55. The Remote Breathing Apparatus

Stowage

After use the facepiece should be removed from the hose, anti-dim fluid applied and it should then be placed in the bag provided. The R.B.A. plus anti-dim fluid should always be carried and stored in its own case.

Fitting

It is important to note that full protection will only be obtained if the facepiece is properly fitted to the face of the wearer. Immediately

after putting on the facepiece, the wearer must test the fit for gas tightness by placing the palm of one hand over the end of the breathing hose and attempting to inhale. If he can, it indicates that there is a leak (usually incorrectly fitted facepiece). This must be rectified before attempting a rescue from a contaminated area.

Signals

Under normal conditions it should be possible for the rescuer to hear orders shouted to him from outside, and in most cases he, by shouting into his facepiece, can communicate with the No. 3 man paying out the hose. It is important, therefore, that this man keep the end close to his ear.

If this means of communication with the rescuer is not possible it is imperative that the attendant No. 2 pays careful attention to any pull he may receive on the signalling line. In some cases it may be difficult to distinguish the difference between deliberate signals and normal or accidental pulling on the line during the rescue operation. If in doubt the No. 2 man should shout to No. 1 for a repetition.

The following two signals are those made by No. 1 pulling on the signalling line:

Three distinct pulls—haul in hose.

A series of rapid jerks (not less than five)—I need assistance.

Precautions

Every member of a Heavy Rescue Party must be trained in the use of this apparatus. Whenever one man is using a set, a second set must always be held in reserve at instant readiness (two sets are carried on each Heavy Rescue Vehicle) with the second rescuer wearing it, apart from putting on the facepiece, in case the first man requires help. If both sets are in use, a third should be obtained from another Rescue Party or sent for as a standby.

Practice Drill

It is suggested that practice in the following drill for utilising the apparatus will enable rescuers to make the best of the apparatus, if and when the need arises for its use. The team consists of three men, Nos. 1, 2 and 3, whose principal duties have already been outlined.

No. 1 secures his waist belt and then attaches the facepiece to the breathing hose. Next, he ties a 12 m lashing around his waist (using a bowline) for signalling. He then pushes his safety helmet to the back of his head (chin strap now around his neck) and fits the facepiece, tests for gas tightness and if satisfactory returns his helmet to the correct position.

No. 2 ensures that the signalling line is securely tied around the waist of No. 1. He then pays out this line and acts as immediate assistant to No. 1 for the purpose of signalling and communication.

No. 3 pays out the hose (assisted by No. 2 if possible).

No. 1 takes in with him a hand-lamp and such small items of equipment as may be necessary.

CHAPTER 8 DEBRIS

In general, there are two methods by which people trapped under a pile of debris can be extricated:

(i) By clearance of debris, i.e. by removing the debris piece by piece until the victims are uncovered and freed.

(ii) By the construction of crawlways and linking of voids.

In both these operations, a very important principle must be borne in mind. If any one survives at all inside or under a large pile of debris after a building has collapsed, it is because some heavy timber or a floor or other portion of the structure has fallen or remained fixed in such a way as to protect this person from the main impact and weight of the debris. In a similar way the presence of furniture can sometimes protect a casualty. Unless something of this kind has happened it is unlikely that the casualty will survive.

This arching or lean-to may be of a very unstable nature, and, unless great care is exercised, it may collapse. Internal collapse can be avoided only by disturbing the debris as little as possible during rescue operations and by making sure that, as one portion of the debris is removed, the remainder is not dislodged and allowed to slide or fall in. Careful observation of these principles makes for greater saving in life in two ways: firstly, by minimising the risk of further injury to trapped persons, including possible suffocation by dust; and, secondly, by making for greater speed in the rescue operation, because the less debris that has to be handled, the less work there is to be done in effecting the rescue.

The question of how little debris need be moved to get rapid extrication is one which must be left to the intelligence of the leader. Sometimes the removal of the smallest possible amount of debris may not necessarily be the most rapid method of releasing the trapped person. Thus, it may be far quicker, in the long run, to move a heap of debris than to cut through a girder. Such factors as the accessibility of the debris to be removed, the number of men available for the work, the nature of the debris, etc. all have an important bearing on the question of how quickly the job can be done.

Whereas speed is unquestionably a most important factor in all rescue operations, speed without safety to both the rescuer and

victims may quite easily defeat its own ends. The ideal is speed with safety.

When Debris Clearance is Necessary

If no information is available regarding the approximate position of persons trapped in debris rescue can usually be effected only by general debris clearance (Stage 5).

The essential difference between debris clearance as a rescue operation and debris clearance to clear a site is that, while the latter is straightforward and can be done after the life-saving phase by mechanical means, the former demands considerable expedition as well as care to avoid further injury to casualties.

In general, the guiding principle is that, so long as there is a reasonable chance of recovering casualties by debris clearance, it must be proceeded with by the rescue parties with unremitting effort. The Rescue Service must continue at work until it is certain that any persons still buried are no longer alive, and the responsible officer, according to local arrangements, decides that operations can be discontinued.

Methods of Debris Clearance

When debris clearance is undertaken for rescue purposes, the debris should, if possible, be moved clear of the demolished building, and not merely from one part of the site to another. The practice of 'turning over' debris should be avoided wherever possible, as it usually leads to confusion and unnecessary duplication of work.

Debris can be removed by hand or by using receptacles found on the site, e.g. dustbins and buckets, and manhandling these to a selected spot where the debris is to be dumped. When removing debris in a confined space or over obstacles it is best to form a human chain. The bins, buckets, or other receptacles being used are passed from man to man and emptied at points known to be clear of casualties.

It may sometimes be necessary when clearing debris to cut a lane through it to reach a casualty. Great care must be taken in so doing to ensure that the sides of the lane do not collapse. These can be made safe, where necessary, by a simple form of timbering and strutting.

Precautions in Debris Clearance

Great care must be exercised in the use of edged tools for the removal of debris, otherwise serious injury may be caused to casualties. Debris in the immediate vicinity of a casualty, or close to a place where a casualty is likely to be, should be removed by hand, using the debris gloves supplied for the purpose, or with the help of the entrenching tool. In this connection, it must be noted that it is sometimes far from easy to recognise a body in a pile of debris, particularly after a fire or when large quantities of lime and dust are present.

MEN MUST NOT BE ALLOWED TO CLIMB ABOUT ON TOP OF A PILE OF DEBRIS DURING THE CLEARING OPERATION UNLESS IT IS ABSOLUTELY NECESSARY. Where it is essential to clear debris from the top downwards, men should be stationed in such a position that they can pass timbers and other pieces of debris to one another. Timber should be withdrawn from debris only when it is certain that no further collapse will be caused with the possibility of additional injury or danger to persons trapped.

ACCESS TO VOIDS: LINKING OF VOIDS: THE DEBRIS CRAWLWAY: RESCUE FROM BASEMENTS

When the position of trapped persons is known, it is often quicker, and in many ways better, to reach them by making a crawlway under or through the debris, linking existing voids wherever possible, so as to cause the least disturbance to the main pile.

Strutting and Lining

Material for timbering and strutting the crawlway can normally be found at the scene of the occurrence, the timber from the damaged building being cut to lengths as required.

Simple props with headpieces are most suitable for holding in position large pieces of debris such as collapsed floors, roof timber and heavy pieces of masonry. The props must be wedged into position and fixed so that they will not slip or become loose and fall out if displacement takes place in the debris, but in no case should they be used to jack up or raise the debris. Props should be kept as nearly as possible in vertical line with the load taken so as to avoid sliding at the head. The feet can probably be held firmly in position by packing. Props must also be placed so as to avoid obstructing the use of the

crawlway and, where possible, should permit the passage of a stretcher. Whenever possible, a crawlway should be driven along against a wall, as this will greatly simplify the operations of strutting and timbering.

Size of a Debris Crawlway

The size of the timbers used for strutting is necessarily governed by the nature of the job and the material available. It is, however, better to have them too heavy rather than too light, especially having regard to the uncertainty of the weight they may have to carry. And, as already stated above, a crawlway in debris should, when possible, allow room for bringing out a casualty, hence it must not be too small nor the bends too acute to prevent passage of a standard or improvised stretcher.

Handling Casualties in Crawlways

Severely injured casualties should be brought on a stretcher where possible and, if necessary, secured to this by a stretcher lashing. The standard webbing bands should be used in preference to lifting the casualty by hand, and as in most cases it is very difficult to determine at first the nature of the casualty's injuries, it is safer to assume that they are serious. Slightly injured casualties can be easily brought out through a quite small crawlway by means of a board to which the casualty is lashed, the board being drawn out by means of a rope attached to it. An uninjured person should be able to crawl out.

Rescue from Basements

The first essential is to try and discover the layout and extent of the basement, the location of the entrance (or entrances) and emergency exits and whether or not there are basements in adjoining premises. Steps should also be taken to try and determine by examination whether or not the floor above the basement has collapsed.

Entrance to a basement may be sought in one or more of the following ways:

- (a) By clearing an entrance leading to the basement.
- (b) By clearing an emergency exit, manhole, coal chute, etc.
- (c) By breaking through the wall from an adjoining basement which has not been so severely damaged. To increase the probability of reaching quickly a void which may have been formed by the collapse of the basement ceiling, it is better to

break through the wall at a point near a corner of the basement. Consideration must of course be paid to the construction and thickness of the wall. If the basement ceiling has collapsed, a mass of debris may be revealed when a hole is cut through the wall.

- (d) Where the ground floor has not collapsed, a small area may be cleared of debris and entrance gained by cutting a hole in the floor.

Once access has been gained to a basement where the ceiling has collapsed, such voids as exist must always be propped and made safe against further collapse. This work can be done by some members of the party while others are attending to the casualties.

General Precautions

- (a) Where dust is troublesome, a handkerchief or cloth worn over the nose and mouth will prevent serious inconvenience.
- (b) Protective-helmets must be worn to avoid minor head and face injuries.
- (c) Dust goggles should be worn to save the eyes from dust and grit.
- (d) The man working at the face should have a life line attached to his waist, tied with a non-slipping knot (bowline) so that he can be easily traced if the debris collapses over or behind him.
- (e) Debris gloves must be worn, as they save minor hand injuries which may cause unnecessary delays.
- (f) Extra care must be taken, especially in the use of edged tools, on nearing a trapped person.

CHAPTER 9 LIFTING AND HAULING EQUIPMENT

Levers

The purpose of all lifting or hauling devices is to gain sufficient power to lift or hold a large load with a small force suitably applied. The simplest appliance for gaining this power is the lever. There are two principal ways in which a lever can be used, as illustrated in Fig. 56. In each case the advantage gained depends on the distance of (A), the centre of the load, and (C), the point where the force is applied, from (B), the fulcrum.

Fulcrum Blocks

A fulcrum should be of hardwood, never of brick or other crushable material. It must be resting on a firm base which should be as large as practicable so as to distribute the weight to be lifted. The fulcrum must be placed as near to the weight as is possible under the circumstances, and it should not be placed at any point where there is a possibility of a casualty being buried immediately below. An appreciation must be made as always before using the lever to ensure the equipment is strong enough, as a collapse would, of course, be disastrous to a casualty.

Lifting

Power should be applied as near to the end as practicable. When more than one lever is used the weight should be lifted evenly.

Hydraulic Rescue Equipment

In the past this technique has been carried out with either a heavy house, lifting jack or a very heavy lever. The more modern practice is to employ the tremendous mechanical advantage which is now available in the shape of a ram or one of two spreader attachments which can be coupled to a standard type of hydraulic pump. The power per weight of equipment can be readily appreciated by the fact that a pump and ram weighing approximately 9 kg can lift a load of 10 tonnes.

78

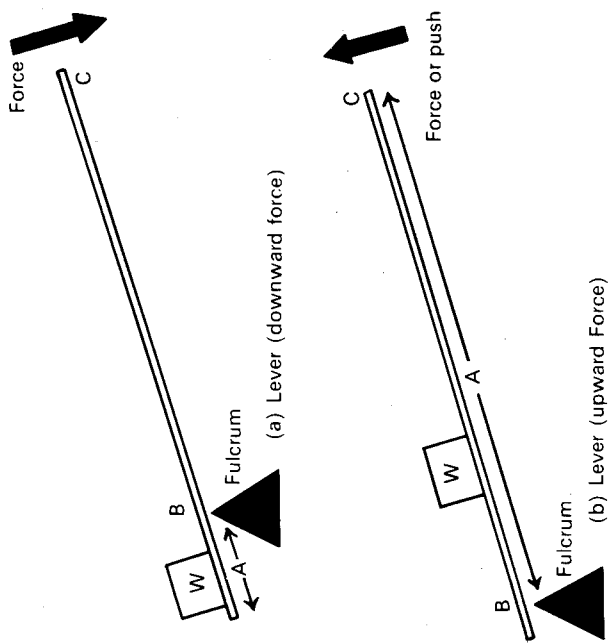

Figure 56. Use of a Lever

Contents of Kit

The Hydraulic Rescue Kit consists of the following major items:

- 2 Hydraulic Pumps
- 2 2 m lengths of pressure hose
- 2 rams of 10 tonnes capacity plus serrated saddles
- 2 screwed adaptors for ram plungers
- 1 wedge spreader
- 1 alligator spreader
- 2 flat base plates
- 2 ram toes
- 2 plunger toes

79

It will be noted that each set has two basic jacking units, i.e. two pumps and two rams and the various fittings for each ram. In addition there is provided one wedge spreader and one alligator spreader. The reason for this is that there will be a number of jobs where two jacks working simultaneously will have to be used, but relatively few occasions where two of the same type of spreader are required together.

Method of Operations

The apparatus is operated by oil pressure from the pump through a 2 m length of hose to the ram and its accessories or to the spreaders.

The various items comprising the kit can be connected or disconnected by finger-operated screw couplers. No tools are required. When the lifting or spreading attachment has been coupled to the hose, power is applied simply by operating the hand lever on the pump.

Note: If undue force has to be applied to the operating handle when the ram or spreaders are near the end of their travel, cease pumping immediately otherwise damage to the equipment may occur. The Australian pump has an inbuilt relief valve, but as explained below, unless the valve is changed to match the lighter loads, protection is not available when lighter loads exceed permissible limits. Further, the valve will not blow when the ram plunger nears the end of its travel.

The Components

Pump Hand operated, normal working position flat on floor with foot on foot plate, can be used in any position except with the oil reservoir pointing downwards, i.e. hose connection uppermost. Operating lever has metal clip to secure it in position so lever may be used as carrying handle.

On the right hand side of the pump is located the *release valve*. This must be tight when the load is being lifted and unscrewed a couple of turns when the time comes for the ram or spreader to be closed up. Lowering can be very finely adjusted by use of this control.

Inside the head of the pump there is located a blow-off valve, which is designed to release when the pressure in the system exceeds 68 900 kPa. As the area of ram base is almost 13 cm², this means that the ram will lift 9072 kg or almost 10 tonnes before the blow-off valve operates.

This ram and pump are well protected against overloading but not so when using any toe configuration, the alligator spreader or the wedge spreader. These would require the relief valve on the pump to be changed to one with a much lower relief pressure.

Obviously this cannot be done—the valve must be pre-set for maximum load, i.e. 68 900 kPa.

It is therefore of great importance that the load of 5 tonnes using toes, 1 tonne using the alligator spreader and 750 kg on the wedge spreader should not be exceeded.

Ram This is simply a compact metal cylinder weighing about 2.3 kg, out of which extends a metal plunger when oil is pumped in under pressure. When closed up the overall height is 150 mm—full extension is 230 mm. Although this lift seems extremely small it does enable the ram to be operated in very confined spaces initially, and by the normal process of packing as the operation proceeds a 200 to 250 mm opening can be rapidly achieved. Using the ram itself on a vertical lift, 10 tonnes is the limit. If, however, the *base plate* and *ram toe*, or the *plunger toe* and *ram toe* are being used, a load of not more than 5 tonnes should be applied. This is because the load is being lifted on one side of the central axis and a bending movement is set up in the ram.

Hose 1.8 m lengths with a male coupler at one end and a female coupler at the other. Hoses are interchangeable and are pre-charged with oil ready for immediate use. A slight seepage of oil is of no consequence when couplings are being made or broken. Great care should be taken to ensure inner washers are not displaced or lost and that no dust or grit enters the system when coupling up.

The *ram toe* is a collar which screws on the top of the ram cylinder and has a lifting lug projecting from it. When used in conjunction with the base plate, jacking can commence from an opening about 50 mm high, instead of the 150 mm required for the straight ram.

The *plunger toe* screws on to the screwed adaptor and when used with the *ram toe* provides a very useful type of spreader.

Experience will dictate which one of these many combinations is the correct one for the job.

Wedge spreader Where clearances for operating the ram are nil, this wedge can be carefully driven in and then power applied to it with the pump. An initial lift of about 63 mm can be achieved but the weight at the tips of the wedge must not exceed 750 kg.

Alligator spreader This screws on to the top of the ram body and is an enlarged version of the wedge. When fitting, the serrated saddle is removed from the ram and the push rod of the alligator spreader inserted into the hole in ram plunger. This is *important*. Check and see that it is so.

When closed the spreader requires an opening of 32 mm but has a maximum opening of 305 mm. The weight on the tips of the jaws should not exceed 1 tonne.

Maintenance

Oil check From time to time the oil level in the pump should be checked. This is done by holding the pump vertically and removing the screw at the rear of the oil reservoir. A dip stick is attached to the screw and if necessary oil should be added to bring the level up to the notch on the stick.

Note: Only good quality hydraulic jack oil should be used for topping up. Hydraulic brake fluid or engine oil should *not* be used. In cases of extreme emergency, however, any non-viscous liquid can be used, e.g., SAE 10 motor oil or even water. If this has occurred, the entire system should be drained at the earliest opportunity.

Air in the system Should air get into the system it will not function effectively. Difficulty will be encountered in getting the ram or spreaders to extend or hold their extended position. Air should be expelled in the following way:

- (i) Connect ram to pump and fully extend it.
 - (ii) Open release valve.
 - (iii) Invert ram and push down on plunger until fully collapsed.
 - (iv) Close release valve.
 - (v) With pump vertical (hose end downwards) give 8 to 12 rapid strokes.
- Repeat the procedure, if necessary.

82

Blank caps Whenever any item of the kit is not in use the blank cap should be screwed into the coupler to protect the valves from dirt and grit.

Accessories Apart from keeping all screw threads clean and oiling the moving parts of the wedge and alligator spreaders, no maintenance is called for.

Special Features of the Equipment

The entire kit is very light and portable considering the fact that the two rams have a combined lifting capacity of 20 tonnes.

The pump permits very selective control over lifting and lowering.

The flexible hose allows the power tools (ram and spreaders) to be operated in a position that may be inaccessible for normal type jacking equipment. It also allows the operator to keep well clear of the actual job.

The ram and spreaders will work upside down, sideways, any way. They are still equally effective.

It is important to realise that the hydraulic rescue set is not only an extremely efficient lifter, but it is also just as effective a pusher.

Jacks

If hydraulic equipment is not available, provision must be made for 2, 5 and 20 tonne jacks.

Use of Jacks

For the effective and safe use of jacks the following points must be observed:

- (a) The jacks should stand on timber or other sound footing of sufficient size to distribute the load, otherwise instead of lifting the load the jacks will be forced into the ground.

Important Note

The information detailed above refers to the PORTO-POWER hydraulic rescue equipment only. Should any other type of equipment be issued the same principles apply, however there may be some variation in the component parts and the method of operation.

IF ANY DOUBT EXISTS, ALWAYS REFER TO THE MAKER'S HANDBOOK FOR INFORMATION.

83

- (b) As the weight is raised it should be safely supported by timber packing or other solid material in case the jack should fail. The jacks should be relieved of the load as soon as possible. (Pack as you jack.)
- (c) Suitable packing such as hard timber and double wedges should always be used between the head of jacks and the surface of any load liable to slip, such as when metal to metal contact occurs.
- (d) Every effort should be made to operate the jacks in an upright position, but if this is not possible suitable packing should be used to prevent slipping or skidding when the load is applied.
- (e) When two or more jacks are used simultaneously to raise the same load, they must be operated in unison to avoid tilting the load and also to avoid bringing too much weight on to one jack with consequent risk of failure.

Holdfasts

These are used in rescue for the purpose of anchoring a line, rope, wire rope or chain which will be under strain. They will fall into two main classes:

- (a) *Constructed*: Those which have to be set up, e.g. by use of pickets and lashings or buried baulks of timber.
- (b) *Improvised*: Those found on the site, e.g. reinforced concrete or metal standards, metal framework of buildings, baulks of timber across door openings, etc.

Precautions

In using any type of holdfast care must be taken to pack it in such manner as to prevent chafing, usually by means of sacking wrapped round the holdfast when it is proposed to use a fibre or wire rope. Pickets should be of sound materials, if possible of steel. In most cases 1.5 m is a suitable length, with a diameter of 25 mm or more, hardwood 80 mm and softwood more than 100 mm.

Picket Holdfasts (Figs. 57, 58 and 59)

In ordinary soil pickets are suitable as holdfasts for strains up to 2 tonnes. They may be used as single pickets or, when formed into a holdfast, may be arranged as 1 and 1; 2 and 1; 3, 2 and 1, according to need. The following points should be observed:

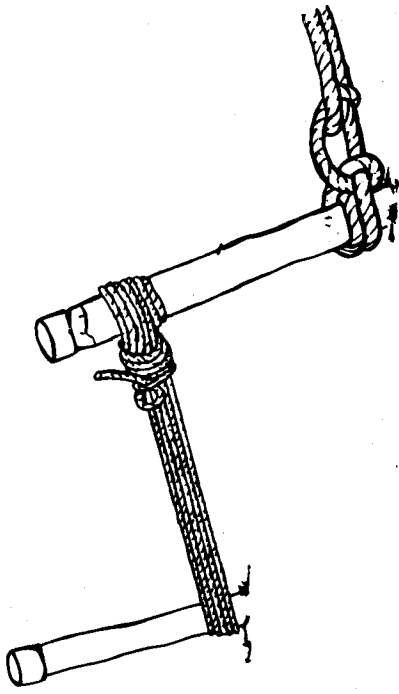

Figure 57. A 1 to 1 Picket Holdfast

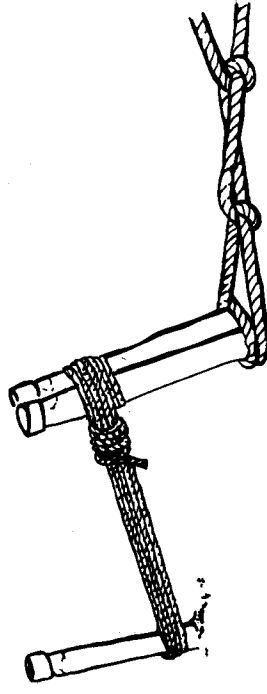

Figure 58. A 2 to 1 Picket Holdfast

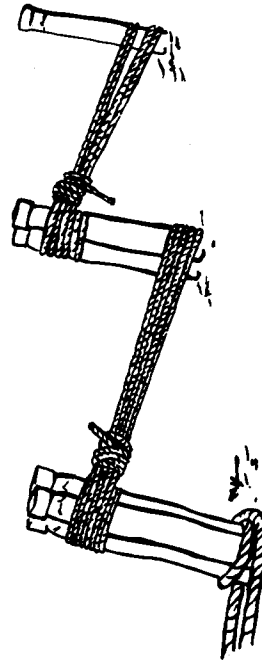

Figure 59. A 3, 2, 1 Picket Holdfast

- (a) The pickets should be driven at 90° to the line of pull, with two-thirds of their length into the ground. The strongest picket should be nearest the weight of the load being taken.
- (b) The lashings connecting the pickets should be at 90° to the pickets and should go from the head of the one in front to ground level on the one behind. This determines the distance between the pickets, which should never be less than 1 m apart.
- (c) Since the weakest part of the rig in use is normally at the holdfast, a man should be stationed to watch this as it may give early indication of overloading or of excessive strain on the guy.
- (d) As a rough guide to safe working loads a 1.5 m × 25 mm mild steel picket properly driven into the ground with good holding qualities will safely support a load of 350 kg.

As the number of pickets in the holdfast is increased so the weight it will support is increased by 350 kg for each picket.

Note: This guide is so dependent upon the state of the ground into which the pickets are driven that it must not be thought of as a rule. As stated it is a rough guide and should always be used as such.

Picket Lashings

The lashing should be started by a clove hitch with 12 mm lashings about 180 mm from the head of the front picket. Four turns should be taken around the backing-up picket and the head of the front picket, placing these above the clove hitch. Frapping turns should be applied around the lashing, finishing off with a clove hitch around the lashing, thus using up whatever spare rope is left. The lashing must be tightened before commencing the frapping turns.

Buried Holdfasts (Fig. 60)

With this type, a good stout piece of timber, a length of steel girder or large diameter water pipe is required. A trench is dug to accommodate the material used and a small outlet made at right angles to the trench to allow the rope or wire to come to the surface. The greater the load to be applied the deeper the trench should be. It must be appreciated that the buried holdfast is only satisfactory where the angle contained between ground level and the rope is small. This being the case the trench need not be filled in but a man should be detailed to check the holdfast when the initial load is applied.

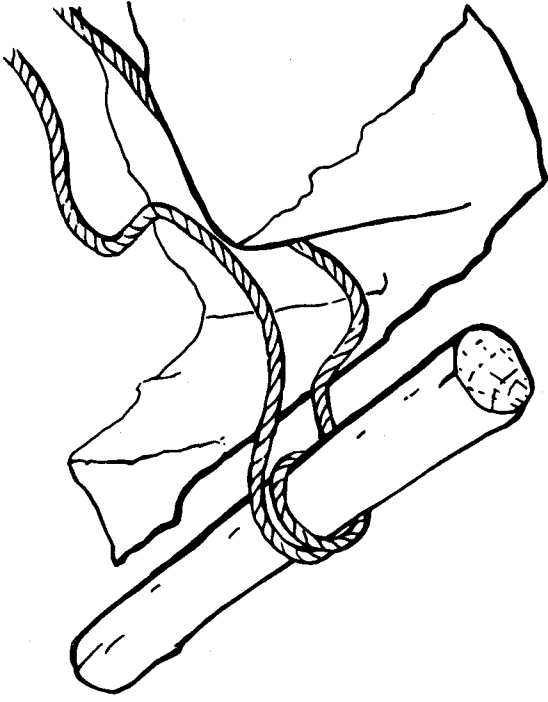

Figure 60. A Buried Holdfast

Improved Holdfasts

When using an improvised holdfast, e.g. an electric light pole, a baulk of timber across a doorway or a heavy vehicle, etc., care should be exercised in assessing whether or not the item selected will in fact carry the load; and secondly that it is correctly placed relative to the rig which is being erected. Badly placed holdfasts can seriously jeopardise the success of any rescue operation in which they are used.

Blocks

- (a) Blocks are used in rescue for the purpose of changing the direction of ropes and for gaining power, when lifting or hauling weights which may be trapping a person or blocking an entrance to a basement, etc.
- (b) If a Tirfor is not available, provision should be for blocks, 1 three sheave, 1 two sheave, and 1 snatch block suitable for use with the 24 mm or 16 mm fibre ropes.

- (c) The snatch block differs from the others in design and is a single-sheaved block with an opening in one side of the cheek or shell and strap so that a rope can be engaged or 'snatched' on the sheave without the end having to be reeved through as may be necessary, for example, when the ends of the rope are secured or inaccessible. This opening is closed by a hinged or pivoted portion of the strap.

Tackle

- (a) A tackle is formed by reeving rope through two blocks and is used in rescue work for:

- (i) Lifting a load.
- (ii) Hauling a load.

- (b) The following terms are used in connection with a tackle:

Reeving The operation of passing the rope round the sheaves of the blocks.

Running end The part of the rope which is 'made fast' to the becket of a block.

Hauling part The free end of the fall or rope to which the power is applied.

Returns The ropes between the blocks.

To overhaul To lengthen the distance between the blocks by adjusting the tackle to the required length.

To Round in To bring the blocks closer together.

Chock-a-block When a tackle is chock-a-block the blocks are as close as they can possibly go (approximately 1.5 m with blocks which will take a 24 mm rope).

Reeving Tackle (Fig. 61)

To 'reeve' a tackle, two men should stand back to back about 2 m apart, with the blocks slightly in front of them between their feet and the hooks pointing outward. The coil of rope should be to the left of the top block for lifting tackle, i.e. the three-sheave block for the 3/2 tackle. The first man should reeve the standing end of the rope through the lowest sheave of the top block, then pass it to the second man who will reeve it through the lowest sheave of the second block.

The rope should be passed successively through the sheaves of both blocks from left to right and finally made fast to the becket of the second block by two half hitches. The running end should be secured to prevent it from slipping.

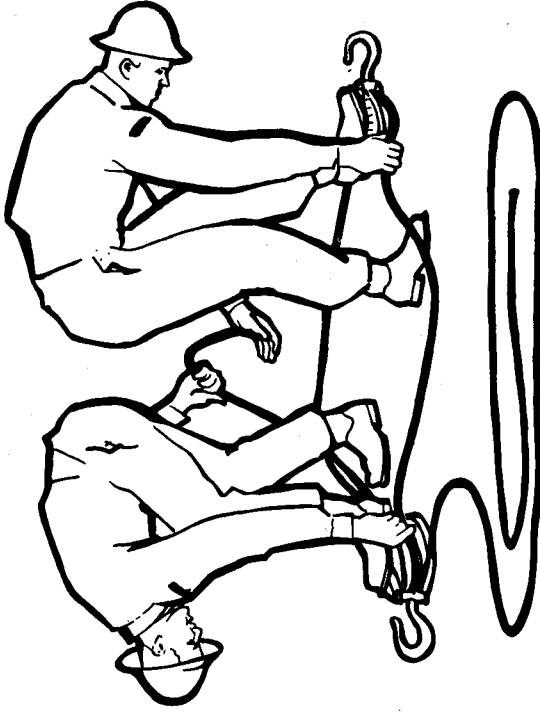

Figure 61. Method of Reeving a Tackle

Types of Tackle

When referring to a particular tackle the following terms are used: 3 and a 2 tackle—three-sheave block and a two-sheave block.

2 and a 2 tackle—a two-sheave block with a two-sheave block.

Note: 'Jinny wheel', or single-sheave block, commonly used by builders for hauling up or lowering material, is not used in rescue but a similar rig can be made using the snatch block.

The tackle most commonly used in rescue is the 3 and a 2, using the three-sheave block and two-sheave block provided in each set of equipment, if no Tirtor is supplied.

The snatch block is used with derricks, sheers and gyps to allow change of direction of the rope and facilitate hauling.

Using the 60 m 24 mm fibre rope and the 2 and a 2 tackle, the following maximum loads can be dealt with:

- (a) Lifting 1500 kg
- (b) Hauling 1800 kg

The maximum distance a weight can be moved with this tackle is 8 m.

Lifting Tackle

A lifting tackle has the weight attached to the moving block (the lower block) and the hauling part of the fall coming off the fixed block (or upper block).

Hauling Tackle

A hauling tackle is one in which the hauling part of the fall comes off the moving block to which the weight being hauled is attached. The fixed block is made fast to a holdfast, or otherwise anchored.

STRENGTH OF TACKLE

Lifting Tackle

When calculating the capabilities of a lifting tackle it must first be realised that only the returns *between* the blocks are assisting to lift the weight and that the running end is not helping in the lifting. The power is exerted directly on it and in the opposite direction to that in which the weight is moving.

Factors to be taken into consideration in calculating the strength of a lifting tackle are:

- (a) The SWL of a rope $\frac{D^2}{100}$ in kN.
- (b) The number of returns at the moving block (including the running end if it is made fast to the moving block).
- (c) The loss of efficiency of the tackle owing to friction. One-third reduction allowed.

Example Using a 3 and a 2 tackle reeved with a 24 mm rope.
 (SWL of rope) \times (Returns at moving block) $\times \frac{2}{3}$
 (friction loss);

which is $\frac{24^2}{100} \times 5 \times \frac{2}{3}$
 $= \frac{576}{100} \times 5 \times \frac{2}{3}$
 $= 19.2 \text{ kN}$

Hauling Tackle

When calculating the strength of a hauling tackle it must be remembered that the hauling part of the fall is pulled in the same direction as the weight to be moved and assists the returns to move the weight. The hauling part must therefore be included in the calculation assessing the number of returns at the moving block.

All other considerations in assessing the strength of a hauling tackle are exactly the same as for a lifting tackle.

Example Using a 3 and a 2 tackle reeved with a 24 mm fibre rope.
 (SWL of rope) \times (Returns at moving block plus hauling part)

$\times \frac{2}{3}$
 which is $\frac{24^2}{100} \times 6 \times \frac{2}{3}$
 $= \frac{576}{100} \times 6 \times \frac{2}{3}$
 $= 23 \text{ kN}$

Length of Rope required for a Tackle

The longest length of rope carried on a rescue vehicle is 60 m. It is therefore necessary to know—

- (a) The maximum length of tackle that can be reeved with this rope.
 - (b) How to calculate the length of rope required for a tackle that will move a weight through any given distance.
- The factors to be taken into consideration for calculating the length of rope required in a tackle are—
- (a) The number of returns between the blocks plus the hauling part. (This is quickly assessed by counting the total number of sheaves in the blocks and adding one for the rope required as the hauling part.)
 - (b) The distance that the weight has to be moved either vertically or horizontally.

- (c) The overall length of a tackle when chock-a-block. (Normally a constant of 1.5 m when measured from hook to hook).

Example It is necessary to move a mass through a distance of 8 metres by means of a 3 and a 2 tackle. To find the length of rope required:

$$\text{No. of sheaves plus 1} \times (\text{distance to be moved chock-a-block})$$

$$(5 \text{ plus } 1) \times 8 + 1.2$$

$$6 \times 9.2$$

$$= 55.2 \text{ metres}$$

Length of rope required.

As mentioned above the length of rope carried on rescue vehicles is 60 metres. Of this, 55 metres would be used in the tackle allowing 5 metres for hauling on by the members of the party.

Anti-twisters

A tackle when loaded is sometimes liable to twist and thus cause much additional friction between the returns. In most cases this can be overcome by preventing the load being lifted from turning, i.e. attaching guide lines to the load. In some cases, however, the tackle may still twist owing to the blocks turning between the swivel hooks. If this happens the load should be lowered and an anti-twister inserted above the becket on the lower block. A pick handle or similar piece of timber is about the size required, and is slid in above the becket and under the two half hitches securing the running end of the

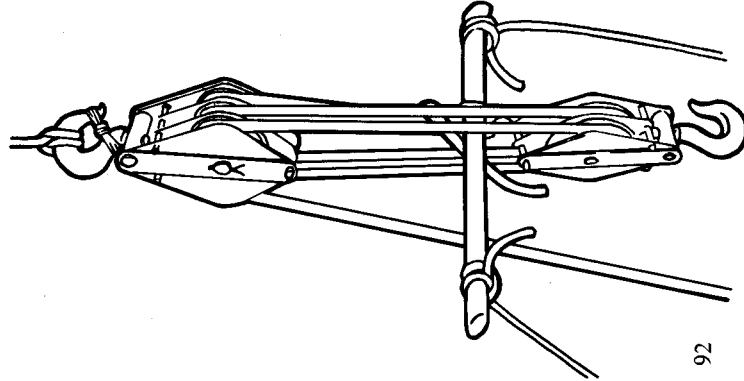

Figure 62. A Three-two Tackle with Anti-twister Fitted

rop to the lower block. Guide lines are then clove hitched to each end of the pick handle so that the anti-twister can be manipulated well clear of the lifting operations (Fig. 62).

The following points should be observed when using tackle:

- (a) The rope must be free from kinks and twists and run evenly over the sheaves.
- (b) All fastenings must be securely made.
- (c) Tackle should be carried, not dragged along the ground.
- (d) Suspended weight should be eased off uniformly and not by jerks.
- (e) Men should be trained to pull together. On the command 'Take up the slack' they should haul in the slack ready to take the load. On the command 'Heave', the men should heave and hold the rope they get. To ensure easy and steady operation the men should be positioned on alternate sides of the rope so as to keep the pull in a straight line.
- (f) The returns near the blocks should not be touched when moving unless absolutely necessary and then only those moving away from the block.
- (g) Not more than one tackle should be hooked in the same sling.
- (h) Blocks should be well cared for, carefully handled and kept free from dirt and grit with working parts sufficiently oiled to ensure free and easy working.

Derricks—Sheers—Gyns

It may be necessary to rig one or all of these, and all rescue personnel should be trained in their erection.

Poles

In choosing poles for such apparatus, it is important to ensure that they are long and strong enough to permit the load to be lifted to the required height after allowance has been made for the length of the tackle when chock-a-block plus the length of the sling or chain in use, the height of the object to be lifted, and, with sheer legs and gyns, additional allowance must be made for the slope of the legs.

Standing Derrick (Fig. 63)

Description A standing derrick is a single spar or pole (or two or

more lashed together for strength) with the butt on the ground or on a solepiece, and the pole held vertical by three, or sometimes four, guys. The weight can be lifted and moved to the right or left and to the front, but only to a limited distance.

To support the lifting tackle and to prevent it from binding on the derrick pole, a short crosstree (or crosshead) about 500 mm long is affixed to the derrick pole by a square lashing with a 12 mm lashing. The crosstree should not be shouldered or bolted to the upright, as this weakens both crosstree and derrick pole. Its normal position is from 450 mm to 600 mm from the top of the pole, but in all cases it is advisable to have it fixed as far down the pole as will give sufficient room to lift the weight the required distance.

With any particular pole the shorter the length of pole bearing the load, the greater the load it can carry within the limits imposed by the type and size of pole in use, Fig. 63 (a).

Guys When using 12.012 m lashings for guy lines, the opposite guys are joined together by a reef knot or double sheet bend if the ropes are wet. The ropes are attached to the top of the pole by a clove hitch.

When the 60.016 m rope is used as a fore and back guy, it should be attached to the top of the pole by a clove hitch made in the centre of the rope.

If it is impossible under certain circumstances to use a guy rope, a 'lazy-leg' may be used. This is done by lashing another pole to the pole of the derrick, using the diagonal lashing.

Pickets The distance of the guy pickets from the foot of the derrick should be equal to twice the height of the derrick if possible, but never less than the height of the derrick. Where conditions are unsuitable for the use of pickets, improvised holdfasts may be used.

Head Rigging If a Tirfor is being used to lift the load, then all that is required at the crosstree is a snatch block, through which is passed the Tirfor wire. Normally the block is secured with a 10 mm chain. Both block and chain hook must be moused.

Footing The ground on which the derrick will stand must be firm, or steps must be taken to make it so. It is advisable to form a shallow hole into which the butt will be placed. If the ground is too soft to

withstand the pressure of the butt, a footing of baulks of timber may be necessary, so constructed as to spread the load over a sufficiently large area of ground.

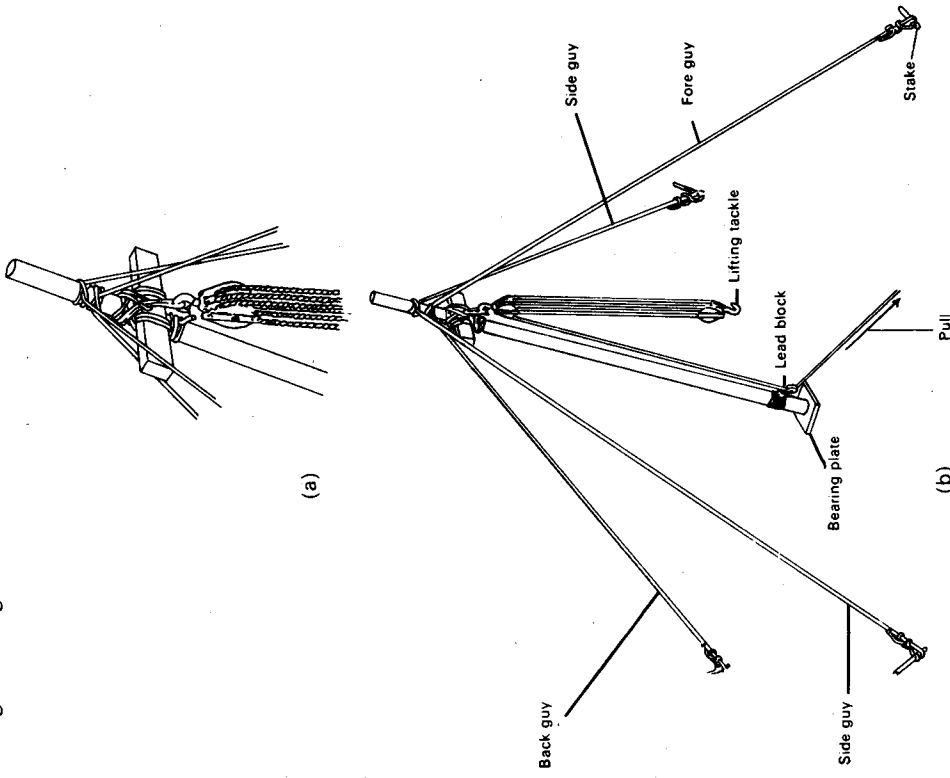

Figure 63. The Standing Derrick

Layout and Preparation

Having chosen the position for the foot of the derrick, allowing for any necessary luffing, the points at which guy pickets will be driven in should be selected. After preparing the derrick, the tackle should be overhauled to the required length and the lower block temporarily lashed to the pole to prevent swinging during erection.

Raising

The initial raising is done by hand under the leader's direction.

The guy at each picket is controlled by a man and as the pole is raised the slack on the fore guy is taken in. During erection the guys are temporarily controlled with a round turn on the pickets and finally made fast with a round turn and two half hitches.

Luffing

When raising a stretcher or weight over an obstruction, such as a wall, it is usually necessary to luff the pole slightly. When this is being done each guy line must be controlled under the direction of the leader. Since the men must work in unison the leader must give precise directions to haul or slacken, and must not leave the men to exercise their own judgment, otherwise misunderstandings may occur and lead to an accident. The maximum luff at any time the derrick is in use must not exceed one-third of the height of the derrick. This limit of incline fixes the distance at which a weight can be picked up.

Sheer Legs

Description Sheer legs consist of two poles with their butts on the ground and their tops lashed together and held in the air by a fore and back guy, forming an inverted 'V'.

Sheer legs can sometimes be employed where the use of a derrick would be impracticable, but can only be used to move the weight in a straight line by swinging the load between the legs. For a given load, the two spars may each be lighter than the one required for a standing derrick.

Layout and Preparation

Two poles should be selected as nearly of equal length as possible.

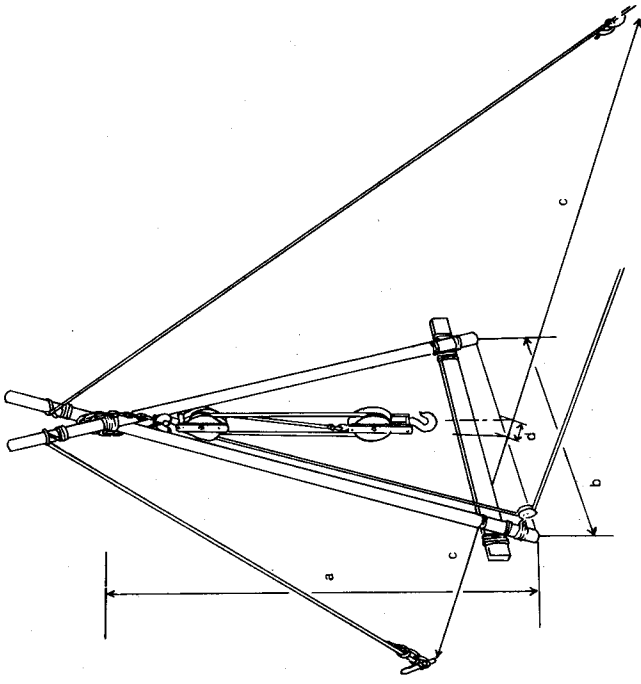

Figure 64. Sheer Legs

and laid with their butts flush together on the ground, the tips being raised to a convenient height for working. Spacing pieces 50 mm to 75 mm thick should be inserted between the poles and the latter lashed with a round lashing. The butts of the poles should be opened up until their distance apart is about one-third of the length from butt to lashing. To prevent the butts from splaying, a ledger should be lashed on near the butts, or as an alternative a 12 m lashing can be used, fastening it to each leg by a round turn and two half hitches, or pickets can be driven in and fastened to each leg. A sling or strop (i.e. a short length of heavy rope or chain) should be passed over the fork or crutch so that it will rest across the poles and not in the lashing between them. The lifting tackle is prepared and hooked into the sling, the lashing being suitably protected. The hook must be moused.

Guis The guys are similar to those required for a derrick but consist of two only, a fore and back guy. They should be made fast above the round lashing by clove hitches in such a way that they will draw the spars together when the stress comes on to them, i.e. the fore guy to the rear pole and back guy to the front pole. The length of the guys is similar to those used with a derrick. In certain circumstances a 'lazy-leg' can be used instead of a guy.

Tackle A sling or strop is passed over the crutch to take the hook of the upper block of the lifting tackle. The hook must be moused. The tackle is prepared to the required length, and the lower block is temporarily lashed to one of the poles to prevent swinging during erection.

Raising

The initial raising is done by hand under the leader's direction. The guy at each picket is controlled by a man and, as the sheer legs are raised, the slack on the fore guy is taken in. During erection the guys are temporarily controlled with a round turn on the pickets and finally made fast with a round turn and two half hitches. The butt must be placed sufficiently far from any obstruction to permit the top of the sheer legs to be luffed over it.

Luffing

A sheer leg is luffed by carefully paying out on one guy and taking in on the other. All men must work in unison under the leader's direction to ensure sound operation and prevent accidents. The amount of luff permissible is similar to that allowed in derricks, i.e. initial luff one-fifth, thereafter one-third of vertical height of rig.

Gyns or Tripods (Fig. 65)

Description A gyn or tripod consists of three poles lashed together near the tips and with the butts forming an equilateral triangle on the ground. No guys are required and the space occupied is small, but only a vertical lift is possible. The lifting tackle is suspended from a sling passed over the crook formed by the tips of the spars. The poles used should preferably be of equal length and strength.

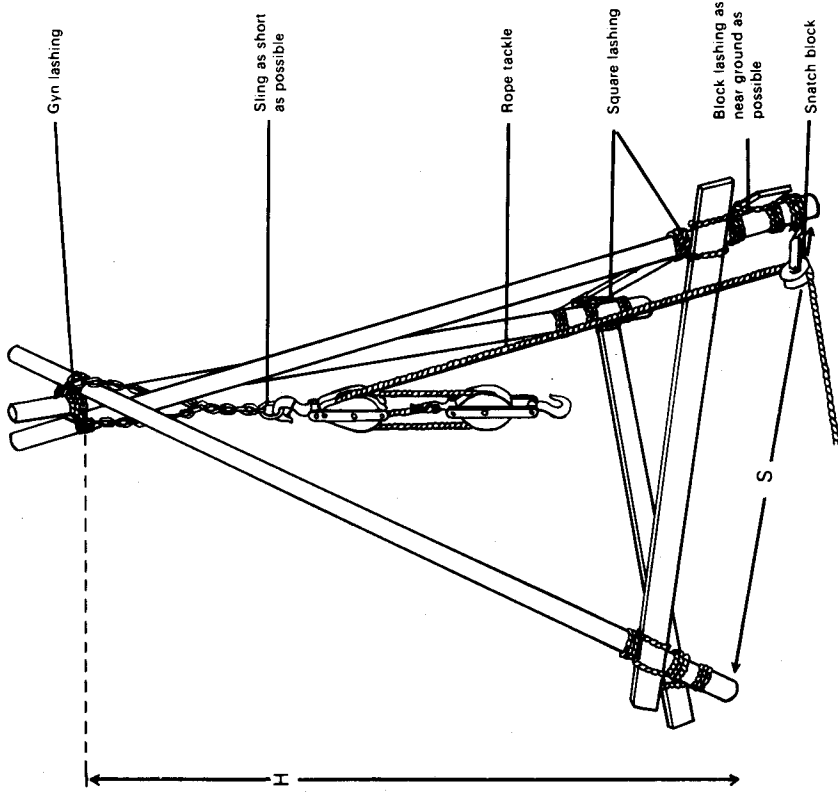

Figure 65. The Tripod

Layout and Preparation

The three poles should be laid out side by side, the butts flush on the ground and the tops raised on a trestle or box. Having placed them they should be marked about 1 m down from the tip of the shortest pole to show the position of the centre of the lashing. The centre pole should now be removed and reversed with its butt on the ground on

the opposite side of the trestle. All three marks should be in line. Spacing pieces, i.e. 50 mm to 75 mm thick according to the diameter of the poles, should be inserted between the poles, after which they are lashed together with a figure-of-eight lashing. The two outer poles are crossed until their butts are at a distance apart equal to about half the effective length of the poles, the top of the centre pole to rest in the crook of the other two.

Tackle A sling or strop, i.e. a short loop of heavy rope or chain, is placed in the crutch in such a manner as to bind the poles together when the weight is taken, the lashing being suitably protected. The hook of the upper block is hooked into the sling and moused. The tackle is prepared and over-hauled to the required length. The lower block is temporarily lashed to one of the legs to prevent swinging during erection.

Raising

The head of the gyn should be lifted as far as possible by hand and the centre pole brought in to form an equilateral triangle. The butts should be evenly spaced at a distance apart equal to about half the height from the butt to the lashing; they must all be on the same level or the weight will be distributed unevenly, and the gyn must be placed so that its head is as nearly as possible over the centre of gravity of the load.

Note: Whether a weight is suspended or not, the gyn should not be left standing unless the butts are secured against slipping by one of the methods used in the sheer legs.

Tirfor

The appliance consists of a machine or casing through which passes a long steel cable which is attached to the load to be hauled or lifted. The operation of a lever handle backwards and forwards pulls the cable through the machine, which, if properly anchored, causes the load to be hauled towards the machine.

The equipment consists of:

- (a) A pulling and lifting unit complete with a swivel hook to enable it to be secured.
- (b) A detachable telescopic tubular steel handle for operating the unit.

- (c) A length of flexible steel wire rope 18 m long, 11 mm in diameter, fitted with a hook at one end, the other end being tapered and fused. This rope is coiled on to a reeler for convenience in carriage.

The machine unit consists of a steel casing enclosing two pairs of automatic jaws which grip the cable passing through the casing. These two pairs of jaws are moved in opposite directions by means of linkage when the handle is operated backwards and forwards. This alternating operation of the handle results in a hauling or lifting movement of the cable of about 70 mm for each complete forward and backward stroke of the lever, which with normal operation on a light load results in a travel of about 4 metres per minute.

The unit provides a mechanical advantage of 1.43. Its size is 610 mm × 305 mm × 152 mm and its mass 17.7 kg. Its SWL (safe working load) capacity is: pulling up to 1.5 tonnes, lifting up to 1 tonne.

Reverse or Lowering Movement

By transferring the operating handle to the lever on the top of the casing, a reversing action is obtained. This passes the cable through the machine in the opposite direction and enables the load to be lowered. The cable is under constant tension while the load is on it and does not jerk or slip during the lowering. Any jerky movement will be due to lack of lubrication, a fault which should be rectified immediately.

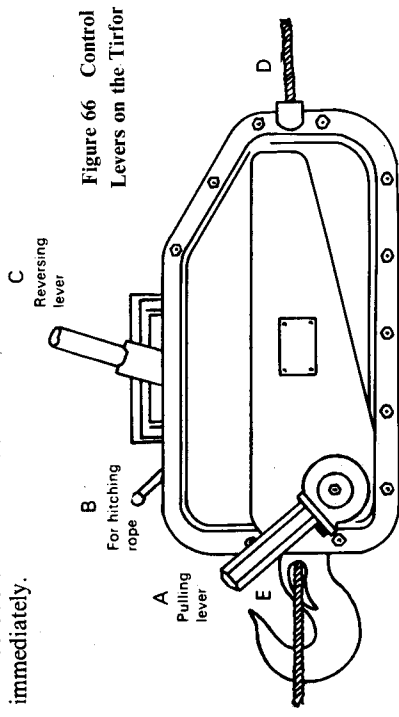

Figure 66 Control Levers on the Tirfor

The following operating instructions are those issued by the manufacturers of the machine:

- (a) Pull clutch lever (B) firmly towards hook on machine, until it is seated in the notch.
- (b) Push the rope into the machine at (D) until it protrudes through the hole in the hook at (E).
- (c) Pull the rope through the machine until the desired length is reached.
- (d) Place clutch lever (B) back into the operating position—this is done by lifting the lever out of the notch and allowing the spring inside the machine to carry it into its operating position. *The rope is now firmly gripped in the jaws of the machine.* To pull the rope through the machine, place telescopic operating handle on pulling lever (A) and move it along the direction of the rope. The rope moves through the machine on both forward and backward strokes of the lever.
- (f) To reverse rope through the machine, remove the telescopic handle from (A) and place it on reversing lever (C) and move it again in the direction of the rope. The rope is paid backwards through the machine on both strokes of the lever.
- (g) To remove rope, pull lever (B) towards hook as in (a) and pull rope through the machine.
- (h) If the operator cannot remove the load with the telescopic operating handle fully extended, the load is too great for the machine, and the snatch block supplied should be used to increase the machine's power.
- (i) Always use slings of sufficient strength to withstand the load.
- (j) Keep the wire rope wound on to the reeler when not in use.
- (k) Never allow any kinks in the rope to enter the machine as this causes internal damage.
- (l) Only use the wire rope supplied with the machine.
- (m) Do not leave the rope release lever (B) in its release position when the machine is not in use as this will shorten the life of the springs.
- (n) Never operate A and C at the same time as this will cause internal strain.
- (o) Never anchor the machine by the tip of the hook, always use a sling.

Lubrication

- (a) Heavy gear oil should be poured into the slot at the top of the machine. The machine should then be shaken to allow the oil to reach all working parts, the surplus oil being drained off through the rope holes.
- (b) Oil regularly through the oil holes which are situated on both sides of the lever shaft A.

Maintenance

- (a) *Before using the machine*
 - (i) Check wire rope to see that it is free of kinks and broken wire. Never use a damaged rope as this jams inside the machine.
 - (ii) Put rope in a machine and move it to and fro with levers A and B; this movement should be easy and free from jerks.
 - (iii) Make sure that the machine is lubricated correctly.
- (b) *When using the machine*
 - (i) Should the machine become filled with dirt or dust from the debris it must be immersed in a bath of kerosene and shaken well. This operation must be repeated until the dirt or debris dust is removed. The machine must be well lubricated before use.
 - (ii) Should the machine become jammed with small pieces of debris or dust, the casing bolts must be removed and one half of the casing should be lifted off. The debris or dirt can then be scraped out of the machine. When the casing is replaced ensure that the cross bar on the spring tubes always fits properly into the slots on both casings. This can be done by looping a piece of wire round the bar and holding it in position until the bolts are fitted. Ensure that the hook and rope entry guide are fitted. Make sure that all nuts and bolts are replaced and properly tightened.
 - (iii) Should the motion become jerky when lowering, this is due to lack of lubrication and the machine should be oiled immediately.
- (c) *After using the machine*

The wire rope must be coiled back on to the rope reeler.

(d) *Examinations at monthly intervals*

- (i) Check for wear or misuse.
- (ii) Make sure that the rope hook is properly fastened on the rope.
- (iii) Measure distance (X) on the rope hook and anchoring hook; if it is more than 70 mm the hook has been strained and should be replaced.
- (iv) Make sure that the nuts and bolts on the casing are fitted and properly tightened.

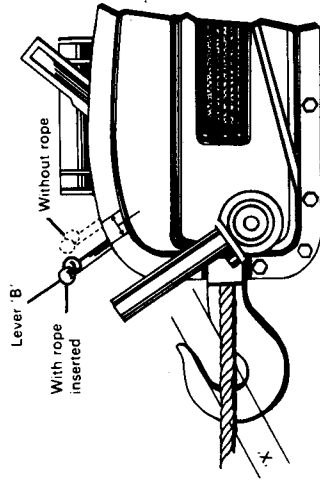

Figure 67. Wear and Strain Check Points

(e) *Monthly check on wear of machine jaws*

- (i) Remove wire rope from the machine and let the release lever (B) return to its normal position.
- (ii) Mark this position on the casing.
- (iii) Pull lever (B) forward into its groove, and feed rope into the machine.
- (iv) Return lever (B) to its normal position with the rope in the machine, as though the machine was about to be used.
- (v) Mark the new position of lever (B) on the casing.
- (vi) There will now be two marks on the casing. The distance between these should never be less than 13 mm; if less it is a sign of excessive wear on the jaws and these should be replaced.

Operational Uses

As a device for lifting or hauling, the machine has innumerable uses and applications. Being light and compact it can be attached to any convenient holdfast or hung from overhead beams, or girders, slung from or attached to derricks or sheer legs, or even attached to the load itself if the cable end is anchored to an immovable object.

The 18 m cable enables the load to be lifted, lowered or hauled considerable distances without changing the position of the machine, and, in conjunction with the snatch blocks, permits the most convenient position to be selected for fastening the machine, while the rope can be taken over the pulleys, through window or door openings, or down through floors to wherever the load may be. It can also be passed over a block at the head of a derrick or sheers to obtain height for raising loads such as blocks of masonry or for erecting tall poles or posts.

Anchoring the Machine

The efficiency and indeed the safety of all these applications of the hauling and lifting machine depends upon the security of the anchorage or holdfast. This may be anything sufficiently strong or immovable, but it must be firm enough not to show any signs of failure under load.

Secured near the base of stout posts, lamp standards, stanchions, bollards, etc., by means of wire bonds, the machine will be able to haul in its cable and move, lift or lower its load without fear of sudden failure.

Safety Features

The machine has three safety features incorporated in its design.

- (a) The clutch lever (B) cannot be engaged whilst the machine is under load.
- (b) If the strain on the lifting lever becomes too much for one man it can be assumed that the machine has reached its safe working limit.
- (c) If the safe working limit of the machine is exceeded there are three sheer pins in the shaft of the pulling lever (A). If rope and machine are in good condition these pins will fail before more serious damage can occur.

CHAPTER 10 TEMPORARY SHORING AND ELEMENTARY DEMOLITION

Introduction

Shoring undertaken by Rescue Parties should normally be limited to that required to (a) enable Civil Defence personnel to carry out their duties with safety; (b) prevent further injury to casualties; (c) obviate danger to the public through the collapse of the building into a highway or other public place. Rescue Parties should not, therefore, spend time in erecting elaborate shoring at incidents; they should erect only such temporary shoring as is necessary to meet urgent requirements.

Generally the materials for improvised and temporary shoring should be obtained from damaged buildings. Most buildings contain timbers of suitable sizes, especially if two or more pieces are nailed together to form the required lengths and cross sections. Such building up should always be done with the timbers laminated, spiked together and with the joints staggered.

Definition

A temporary shore as applied to rescue work is a series of timbers erected so as to strengthen and prevent further collapse of any part of the building.

General Precautions

The purpose of shoring is not to force the damaged wall or ceiling back into its original position, but rather to prevent further movement. Any attempt to force things may result in further damage. It is, however, essential that all shoring be secured into its position. This should be done gradually and without shock to the structure, using the lever and wedge method rather than by hammering into position.

Types

There are three main types: (a) Raking; (b) Flying; (c) Dead or Vertical.

106

Raking Shore (Figs 68, 69 and 70)

(a) This is used to prevent a wall or vertical part of a building from bulging or falling away.

Principal parts The principal parts of a raking shore are the raker, wall-plate and sole-piece or sole-plate. Other items necessary for the erection of a raking shore are cleats, struts (or braces), and wedges. Recommended sizes for these are given below:

| Max. height | Raker | Wall-plate |
|-------------|-----------------|----------------|
| 4.5 m | 100 mm × 100 mm | 240 mm × 50 mm |
| 6 m | 125 mm × 125 mm | 240 mm × 75 mm |
| 7.5 m | 150 mm × 150 mm | 240 mm × 75 mm |

| Sole-piece | Street |
|----------------|-----------------|
| 240 mm × 75 mm | 100 mm × 50 mm |
| 240 mm × 75 mm | 100 mm × 50 mm |
| 240 mm × 75 mm | 150 mm × 100 mm |

Note: These can be either of solid timber, size as stated, or can be made up by different size timbers, i.e. two 100 × 50 mm joists strapped and dogged together would form a 100 × 100 mm raker.

(b) **Method of erecting** A cleat is first nailed to the wall-plate at a point just above the common meeting point of the raker and load bearer.

(c) The sole-piece should be placed in such a position that it takes the thrust of the raker at an angle exceeding a right angle so that when tightening up is done a right angle is formed. This tightening up should never be done with a hammer but a small rebate should be cut from the foot of the raker thus enabling a lever to be inserted in order to tighten it up or folding wedges could be inserted between the foot of the raker and the cleat.

Soft ground can be excavated sloping towards the unsafe wall in order to give the necessary angle. On hard ground the sole-piece will have to be built up to the required angle and spiked or wedged to prevent movement outwards. Alternatively a sole-plate may be constructed by using a plank as wide as the wall-plate. When the bottom of the wall-plate is touching the ground, it could be allowed to rest on the end of the sole-plate nearest the wall and later a cleat may be nailed into position in the right angle thus formed. Further along the sole-plate, where the raker

107

Figure 69. Footing a Raking Shore in soft ground

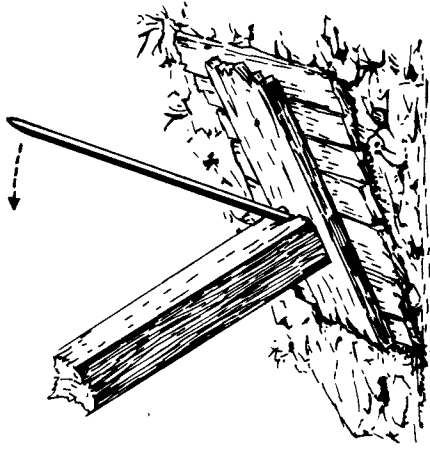

wall should be backed with timber pieces in order to give it continuous bearing throughout its length.

The cleat having been nailed in position, the wall-plate is now held against the wall while the raker is being fixed.

(e) *Raker* The top of the raker is then placed underneath the cleat and the foot placed on the sole-piece. The whole structure is then gently levered into the correct position and a cleat is nailed on the sole-piece behind the raker. Any irregularities in cutting may be remedied by the use of wedges.

(f) *Strut (or brace)* The strut or brace is then fixed. This prevents any movement by the foot of the wall-plate and checks the wall-plate from riding up the wall under stress. The strut should be spiked and if necessary dogged to the raker and wall-plate.

(g) *General.* Care should be taken when setting out that the centre line of the raker and the centre line of the joist bearing should meet at a common point. To

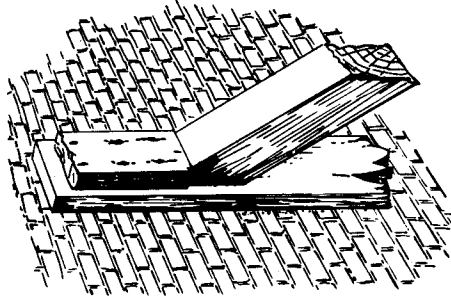

Figure 70. Head of a Raking Shore

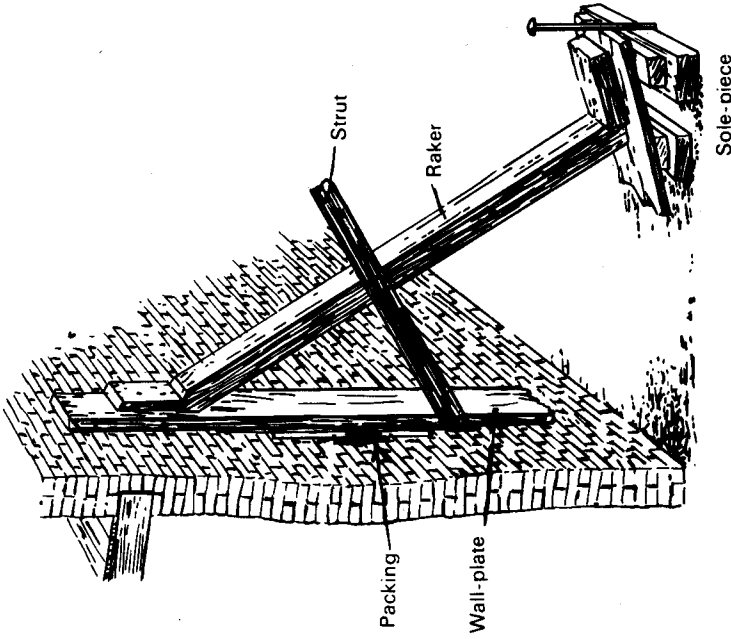

Figure 68. A Raking Shore (hard ground sole-piece)

touches, another cleat should be nailed to the sole-plate approximately 50 mm away from the foot of the raker to allow for the insertion of folding wedges between the cleat and the raker. When the wedges are placed in position and tightened, care should be exercised that this action does not allow the wall-plate to ride up the wall. As a safety measure, the end of the sole-plate outside the raker should be secured by a stake or spike to prevent movement.

(d) *Wall-plate* The wall-plate should be as far as possible continuous throughout its length and when used against a bulging

prevent the wall-plate from riding up the wall use may be made of window sills, oversailing courses or needles placed in ventilator bricks. The best angle to achieve when locating the raker is 30° at the head and 60° at the foot.

Flying Shore

- (a) This is used between the walls of two buildings, the sound wall giving support through the shore to the damaged wall.
- (b) *Principal parts* The principal parts are the horizontal beam, wall-plate and struts. Other items necessary for the erection of the Flying Shore are cleats and wedges and straining pieces. Suitable sizes for these are given below:

| Max. span | Horizontal beam | Wall-plates |
|-----------|-----------------|----------------|
| 3 m | 150 mm × 100 mm | 175 mm × 50 mm |
| 4.5 m | 150 mm × 150 mm | 175 mm × 50 mm |
| 6 m | 150 mm × 150 mm | 240 mm × 50 mm |

Struts

- 100 mm × 100 mm
- 100 mm × 100 mm
- 100 mm × 100 mm

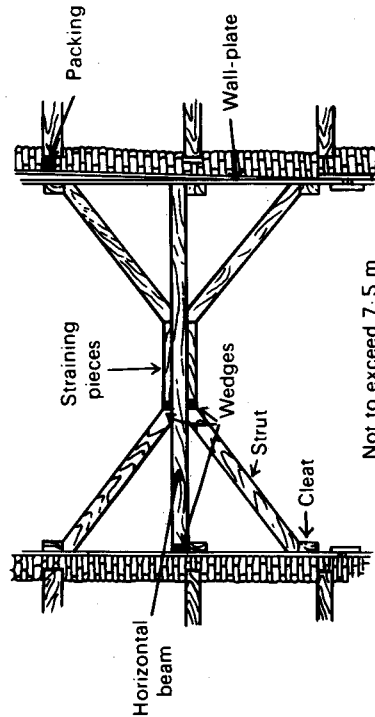

Figure 71. The Flying Shore

(c) *Method of erection* The cleats are nailed to their positions on the wall-plates, the first pair to support the horizontal shore and the other pairs to support the struts. Ensure that the cleat for the horizontal beam adjacent to the sound wall is thick enough to allow for the folding wedges and a good overlap by the beam: endeavour to give the horizontal beam equal cleat-bearing surface at each end. The struts should be set an angle not greater than 45 degrees to the horizontal beam, and should be kept apart on the horizontal beam by straining pieces. The length of these straining pieces is determined by the length of the horizontal beam. It is advisable to set the job out on the ground before erection so that attention can be given to measurements and angles. While the wall-plates are being held in position the horizontal beam with the straining pieces temporarily lashed to it is placed on the centre cleats and tightened by folding wedges inserted between the shore and the wall-plate.

The struts are next placed into position between the cleats and the straining pieces, being tightened by wedges. If wedges are necessary to the lower struts they should be placed between the tops of the lower cleats and the lower struts. Timber dogs may be used to brace the shore rigidly.

(d) *General* The centre line of the horizontal beam and struts should meet at a common point. The wall-plates should be continuous throughout their length —packed between the wall and the wall-plate if necessary—in order to give a continuous bearing.

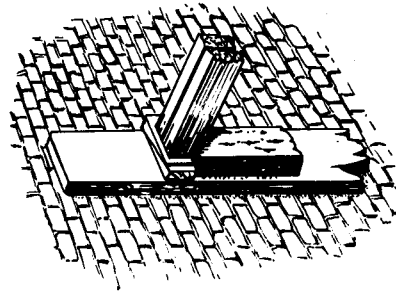

Figure 72. The Horizontal Beam of a Flying Shore

It is not advisable to erect a flying shore between two walls at a distance greater than 7.5 metres apart. Flying shores should be placed along a wall at intervals of 2.5 m to 3.5 m, depending upon the circumstances and the degree of damage.

Dead Shore (Fig. 73)

(a) A Dead Shore carries the vertical load of the wall or floor, and should be erected at all times when rescue personnel are working below a dangerous wall or ceiling, or on a floor above which is in danger of collapse. A careful assessment of the situation should be made before work is commenced and if in doubt place dead shores in position as required.

(b) *Principal parts* The principal parts are the sole-piece, head-piece and vertical or dead shore. Other items used are braces, wedges and dogs.

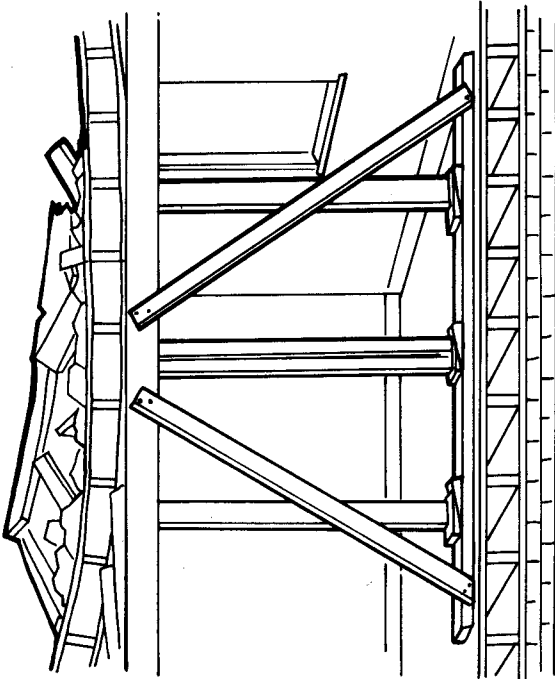

Figure 73. An Improvised Dead Shore

(c) *Method of Erecting* The sole-piece is laid down in position, taking care that it is placed on a solid foundation. The head-piece is held in position and the vertical or dead shores are then placed upright between the head-piece and the sole-piece and securely wedged by a pair of folding wedges inserted between each dead shore and the sole-piece. These wedges should be tightened simultaneously.

In using folding wedges care should be taken that the wedges are 'married' before tightening is attempted. ('Married' means that one point overlaps the other after insertion of the wedges.)

Where braces are necessary they should be long enough to extend diagonally from the head-piece across the shore to the sole-piece and nailed to each in turn.

(d) *General* It must be remembered that vertical or dead shores may be carrying the full weight of the structure above, whereas raking and flying shores mainly oppose the overturning tendency. It is very important, therefore, to have a solid bearing for the sole-piece. The sole-piece must be as broad and as long as possible in order to spread the load. There is no rule laid down as to how many verticals should be constructed, but common sense should dictate this.

When cutting the verticals, remember that the length of each is the distance between the ceiling and floor less the thickness of the head-piece, the floor-plate and about two-thirds of the thickness of the wedges when folded. It is fairly difficult to estimate what load a vertical or dead shore will carry, but the following rules may help—

- (i) The shorter the length, the greater the load carried.
- (ii) The strength is increased if the ends are cut square to fit on the head and sole-piece.

Care must be taken not to drive wedges too tightly or they will have a lifting effect.

Strutting of Openings (Fig. 74)

When the walls near window and door openings are unsafe and are to be shored up, or when the head or sides of such openings are damaged, it is a sensible precaution to strengthen the opening by strutting.

The uprights and struts may be 'pinched' into position, or cut shorter and tightened with folding wedges. Pairs, not single wedges, should be used.

The size of timber usually used on this class of work varies from 100 mm × 50 mm to 175 mm × 75 mm, according to the size of the opening.

If an arch has to be supported, timbers will have to be shaped or packed to fit its entire underside, depending on the shape that the arch has assumed when damaged.

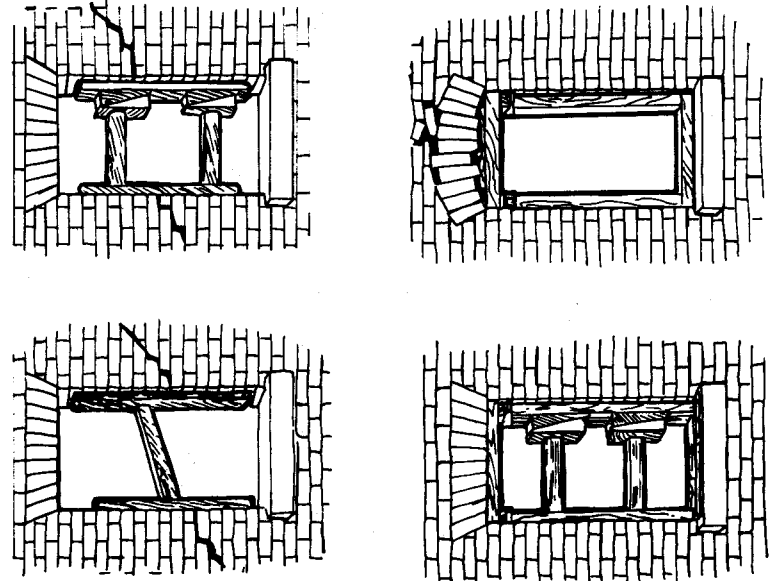

Figure 74. Strutting a Window Opening

Many methods of strutting may be employed, but, whether the opening be window or door, sufficient room must be left between the struts for a casualty to be brought through or to enable a rescue to be effected.

Demolition

Demolition is a highly skilled operation rarely undertaken by rescue parties. Only elementary demolition of the most urgent nature is undertaken by the rescue service, i.e. when lives are in danger.

Two methods available to rescue parties are:

- (a) Piecemeal removal, working down from the top.
- (b) Pulling over by cable attached to vehicle or winch, or by manpower.

Methods adopted depend upon such factors as:

- (a) Accessibility to enable tackle to be firm.
- (b) Degree of urgency.
- (c) Space available.
- (d) Stability of building.

Piecemeal demolition is the safest but it takes longer. When using the cable method, pack out noose to prevent cutting through structure and to pull section, not pieces, which may require to be undercut to fall in desired position. Note that all demolition is likely to create additional dust.

CHAPTER 11 CUTTING GASES; SAFETY REGULATIONS, STORAGE AND USE

When iron or steel obstructions are encountered in the course of rescue work, the most rapid means of cutting a way through is with the oxy-acetylene cutting torch. It should, however, be borne in mind that only readily oxidisable steels can be cut by this process, consequently stainless steel not being oxidisable cannot be cut with ordinary cutting equipment. Cast iron can only be cut by a special technique of weaving the cutting torch very slowly with a semi-circular motion. Brass, bronze and copper, which do not oxidise rapidly, cannot be cut. Bars and thin sections of these metals can, however, be melted away by the high temperature of the flame, and this may on occasions prove useful.

Briefly, the equipment for this method of cutting consists of a cutting torch, a cylinder of oxygen, a cylinder of acetylene, and oxygen and fuel gas regulators, devices which are screwed into the cylinder valves for reducing the pressures of the gases to those required at the cutting torch. To these regulators are connected lengths of hose for conveying the gases to the cutting torch, to which their other ends are connected. The cutting torch is the tool with which the severing of the steel is done.

Oxygen

Oxygen has no smell and does not itself burn, but enables ignited substances to burn more rapidly; e.g. a cigarette or rope which ordinarily only smoulders will burst into flame in the presence of oxygen. From this it will be realised that an uncontrolled jet of oxygen or a leak may be dangerous, as a spark settling on clothing or any other inflammable material will at once be fanned into an intensely hot flame. For this reason oxygen must never be used to ventilate tanks or enclosed spaces.

Storage of Oxygen in Cylinders

For oxy-acetylene cutting, oxygen is compressed into hollow steel cylinders to a pressure of approximately 14 000 kPa when at a

temperature of 18°C. Cylinders are painted BLACK with a domed base and the outlet socket, into which the oxygen pressure regulator is connected for use, has a RIGHT-handed $\frac{3}{8}$ -in. B.S.P. screw thread. Common sizes of cylinder supplied are 7 m³, 3.5 m³ and 1.4 m³.

Dangers and Precautions To Be Taken With High Pressure Oxygen

Oxygen at high pressure in contact with oil, grease or any fatty material causes a rapid reaction with rise of temperature to ignition point. Not only may a fire be started in the pressure regulator and hose, but the sudden expansion of the oxygen so heated may cause an explosion. It is therefore most important to take every possible precaution against the presence of oil or grease on any part during storage or carriage in the rescue vehicle.

The pressure in any oxygen cylinder will rise very considerably with any rise in temperature. Cylinders therefore must not be stored near boilers or any source of heat. If stored or used in the open in very hot weather, they should be shaded from direct rays of sun.

Oxygen cylinders may be stored and used flat or upright, but in operations they should be wedged so that they cannot fall or roll, as the pressure regulator may be damaged.

Before connecting a regulator to a cylinder, the neck should be wiped out (to remove any accidental oil or grease) and any dirt or grit in the threads should be blown out by opening the valve quickly about one quarter turn and closing it again (called 'snifting'). Care must be taken to do this away from any smouldering material.

After connecting the regulator, the valve must be opened very slowly by tapping the valve key. A sudden opening of the valve could cause damage in the regulator.

Acetylene

Acetylene has a pungent, somewhat unpleasant smell (which is a help in detecting leakage). When mixed with oxygen it burns readily from a controlled nozzle forming a very high temperature flame. Note that if there is insufficient oxygen to give complete combustion, a black pungent smoke is produced.

Storage of Acetylene in Cylinders

If compressed in the same way as oxygen for storage in cylinders, acetylene could decompose suddenly, causing a tremendous rise in temperature and pressure which would burst the cylinder. Different techniques are employed whereby cylinders are filled with porous material impregnated with a liquid acetone which readily absorbs acetylene under pressure. Purpose of this porous mass is to hold the gas in innumerable small 'pockets', which prevents decomposition and enables a large quantity of acetylene to be stored in a small space at the quite moderate pressure of 1500 kPa when at a temperature of 18°C. The gas is then known as DA (Dissolved Acetylene). Cylinders are painted MAROON with a flat or concave base, and the outlet socket, into which the acetylene pressure regulator is connected for use, has a LEFT-handed $\frac{3}{8}$ -in. B.S.P. screw thread. Common sizes of cylinders supplied are 7 m³, 3.2 m³ and 1.8 m³. Much less acetylene is used in working than oxygen.

Dangers and Precautions To Be Taken with Acetylene

Acetylene has a very wide explosives range when mixed with air. From 2 per cent to 82 per cent will form a dangerous mixture, the explosion being most violent when the proportions are 65 per cent acetylene to 35 per cent of air. It is therefore most important that leakage of acetylene should be avoided.

It is even more important than in the case of oxygen to store acetylene away from any source of heat, since heat not only expands the gas but aids decomposition and increases the risk of explosion.

Cylinders of acetylene can also become dangerous as the result of a backfire at the torch travelling up the hose and through the pressure regulator, or as the result of rough handling of the cylinder when in use. To prevent damage from a backfire, the acetylene valve on the torch must be shut off with the utmost speed. If the hose should already be on fire or split, the main valve on the cylinder must be closed at once.

Trouble must always be suspected if an acetylene cylinder is found to be hot (it may only be in one spot at the start, where decomposition of the filling has commenced). The cylinder valve, if open, should be closed, and the cylinder removed to a place where damage from

explosion or fire will have the least effect. If possible the cylinder should be immersed in water, or water should be played on it from a safe distance to help cool it off.

Note: Most DA cylinders incorporate a safety pressure relief disc or plug to allow gas to escape should the internal pressure rise above safe limits. Once such a device functions there is no way of controlling the escape of gas, and there is no point in trying to close the cylinder valve if it should be open.

The cylinder should be cooled for at least one hour before any approach is made to it for examination. If already immersed in water, it should be left immersed for at least 12 hours. If being sprayed with water, when it appears to be cool it should be removed and immersed in water for 12 hours. The cylinder should be treated as an explosive missile and the suppliers informed.

Note: Acetylene can form explosive compounds in prolonged contact (unburnt) with certain metals or alloys, in particular those of copper and silver. Joint fittings or piping made of copper should on no account be used, and unburnt acetylene should never be allowed to come into contact with copper or any alloy containing more than 70 per cent of copper. The only exception is the torch nozzle.

Precautions common to all Cylinders (Oxygen and Acetylene)

Never alter the colours of cylinders or attempt to adapt the threads of the outlet sockets. If the threads are burred so that pressure regulator will not screw in easily, label the cylinder as 'Faulty valve' and return to suppliers.

Do not attempt to fill one cylinder from another.

Do not drop cylinders, and if hoisting by crane, derrick, etc., do not use magnets or chain or wire slings. Never use cylinders as improvised rollers for moving heavy items.

Store in a dry, cool place away from oil or acids and other corrosive substances.

Never under any circumstances allow oil to come into contact with the threads on the oxygen cylinder.

CHAPTER 12 LADDERS

Ladders play an important part in rescue operations and it is essential that their construction and uses should be fully understood. Ability to handle and move ladders quickly and safely is an indication of good training and will ensure freedom from accidents and maximum efficiency.

Each Heavy Rescue Party carries (a) two short ladders, which can be coupled, and (b) an 11 m maximum extension ladder.

Short Ladders

- (a) Two short ladders each 2.5 m long coupled together form a ladder approximately 4.3 m long. A ladder of this size can reach first-floor windows of most dwelling houses and also into basements, and will prove valuable when making a reconnaissance.
- (b) Care must be taken that the reinforcement of the ladder is always on the underneath side of the load, and that a firm foundation is found for the bottom of the ladder. In some cases it may be necessary to tie or anchor the bottom; and at other times the top of the ladder may have to be fastened, when one man must 'foot' the ladder until the top has been secured. If an anchorage for top or bottom of the ladder is not practicable, the ladder must be footed while in use.
- (c) These short ladders may also be employed when getting over obstacles, damaged walls, gaps and so on. For bridging a gap, ladders can be used by placing one (or two side by side) over the opening (reinforcement, if any, on the underside) and laying a board or boards flat on the rungs. Wherever possible, one length of board should be used on one ladder, but if this is not practicable, care must be taken to overlap the ends of the boards where they meet in such a way that the rescuer will not trip when carrying a casualty. The ladder or ladders must be long enough to bridge the gap and to have adequate support at either end.
- (d) These ladders must be examined periodically for excessive wear or damage.

120

Extension Ladders, 11 m

The normal issue is the 11 m extension ladder which is in two sections, the upper section sliding on and between the sides of the lower section. Pawls are fitted to the lower end of the sliding section and operate on a rotating shaft; pulling lines are taken through sheaves fixed near the top of each string of the lower section, brought down and fastened to hooks or cleats at the bottom of this ladder, one cleat being attached to the pawl shaft, thus providing endless lines by means of which the top section can be extended, and the pawls which are mounted on the sliding section can be engaged or released. To make it easily distinguishable in the dark the strings of the top section should bear a white line to indicate the 'limit of safety' when extended for use—the overlap of the ladders is normally five rungs. Similarly the 'bottom' of the ladder should have a 150 mm band of white paint. The ladder is strengthened on the underside of all strings by galvanised wire which is stretched tautly in the groove along the edge of the strings, being secured at the top and bottom and kept in position by staples. The ladders are further strengthened by cross-ties of wrought iron rod from string to string at intervals. Ladders should not be painted as paint would hide incipient defects. Clear varnish or treating the bare wood with linseed oil usually proves satisfactory.

Standard Test of 11 m Extension Ladder

- (a) Extension ladders should be tested monthly or more often if necessary. The first test is a visual examination followed by a practical test of the strings and rungs.
- (b) Examine the condition of the strings, rungs, pulleys and pawls and lubricate working parts. Look for obvious defects, especially any displacement of anchoring of reinforcing wires, cracks or shakes in the strings or rungs, loose rungs or missing wedges, riveting of cross ties and position of washers, bent or twisted pawls or pawl shaft, bent cleats, loose guides, frayed ropes, and defective fastenings of ropes to pawl shafts. Pay particular attention to the condition of the strings at the bottom of the lower half of the ladder.
- (c) If the examination is satisfactory, lay the ladder flat on the ground with the strengthening wire on the strings towards the ground; extend it to a five rung overlap on each half, lift it on to two trestles (or boxes, etc.) positioned about 60 cm from

121

either end; measure the distance of a point in the middle of the span from ladder to ground.

- (d) A man of approximately 72 kg should sit gently on the centre of the ladder and after it has reached its limit of sag he should spring off smartly, when the ladder should resume its previous position. If there is a discrepancy between the first and second measurements, further inspection should be made, paying particular regard to the anchoring or stretching of the reinforcement. If it appears that serious stretching has taken place in the reinforcing wire, or other defects becoming apparent during this test, the ladder should be returned to store.
- (e) To test the extending rope, the ladder is erected in its closed state against a wall, two men grip a rung of both the upper and lower sections together to prevent any sliding movement whilst two men endeavour to extend the ladder by pulling on the rope. If the rope proves to be sound, the ladder is extended to its full height and two men again apply their weight to the rope.

- (f) After this test, the ladder should be halved (see paragraph 'Halving Ladders') and each half raised so that the weakest parts of the rungs and sockets may be tested. Each rung should be 'jumped' by a man who has ascended the ladder. The correct method is to transfer the man's weight sharply downwards from each rung to the next with the feet separated as far as the strings will permit. The height of the jump should not be increased nor used to deliver a violent blow to the rung. The ladders should be erected as nearly vertical as safety conditions permit, the head being secured and two men stationed at the foot. The ladders should be reversed and the remaining rungs 'jumped'.

Angle of Ladders when Raised

When a ladder is raised the angle which it makes with the ground should not be too great or too acute. As a general rule the bottom of the ladder should be placed at a distance from the base of the wall equal to about one-quarter of the height to be reached, e.g., to enter a window 8.5 m above the ground the ladder should be footed about 2 m from the wall.

Securing the Top of the Ladder (Fig. 75)

When it is necessary to secure the top of a ladder, this may be done

122

with a lashing line or piece of sashcord. The usual method is by tying it to a piece of timber which is long enough to spread across and inside the width of the window opening.

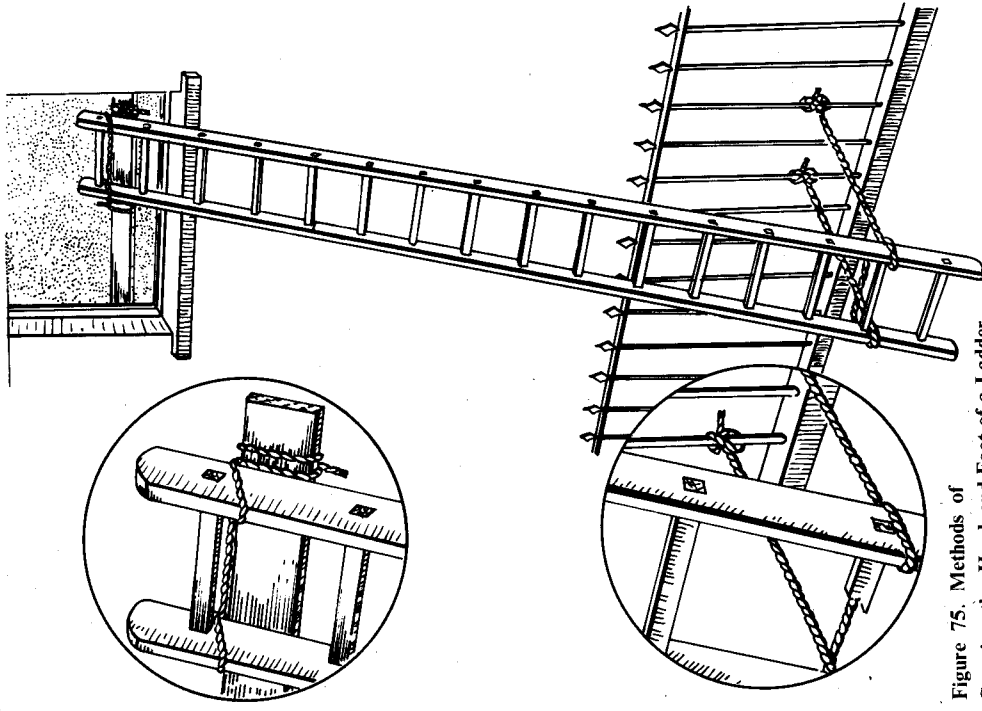

Figure 75. Methods of Securing the Head and Foot of a Ladder

123

Anchoring the Foot of the Ladder (Fig. 75)

This may be done by means of fastening to an improvised picket or pickets, or tying back to any secure object behind the ladder, e.g., railings, gateposts, etc.

Ladder Climbing

The ladder should be climbed steadily, keeping the body erect, the head upright, the arms straight but not tense, without any tendency to hug the ladder, and the hands grasping the rungs at a level between waist and shoulders. It must be remembered that the legs and not the hands carry the weight of the body when climbing. It is generally agreed that it is safe to use the instep rather than the ball of the foot on the rungs. However, it should be left to the individual to make his own decision.

Carrying up Tackle

Each man should be capable of carrying rescue equipment, e.g., crosscut saw, a five-tonne jack or a partially loaded debris bin, to the top of fully extended ladder and descending with it.

Erecting and Extending the Ladder (Three Men)

Normally three men are required to form a ladder team. No. 1 is responsible for the bottom of the ladder, both in carrying and positioning where necessary. Nos. 2 and 3 support the uppermost string of the ladders on their shoulders. On arrival at the site required for erection No. 1 places the bottom of the ladder with the reinforcing wires uppermost as near as possible to its required position and anchors it by 'footing' it. Nos. 2 and 3 working on their respective sides raise the ladder from the underneath side to the vertical position, assisted by No. 1 as soon as it has reached a suitable slope to enable him to grasp the sides and exert his pull. If the reinforcing wires are not now facing towards the building the ladder should be turned in the required direction, ensuring that the reinforcing wires of the ladder will be on the underside. Provided that it has been correctly placed before raising, it should be unnecessary to handle or carry it far in this position. Nos. 2 and 3 face the ladder, each 'footing' it, then pulling on the ropes extend the ladder to the required height ensuring that the pawl is properly engaged on the rung. The ladder is then laid back into

position by No. 1 who walks backwards until the top of the ladder comes to rest where required, i.e. against sill, wall or floor.

Erecting and Extending the Ladder (Two Men)

When no third man is available to 'foot' the ladder, the bottom of a ladder should be placed against a wall, kerb or some other fixed object. The ladder is underrun in the usual manner by the two men, extended to the required height, and the foot of the ladder drawn outwards to the correct distance from the wall.

Halving the Ladders

- (a) In some cases the complete ladder may not be required, or two lengths equal to the length of each section of an extension ladder may be called for, and this can be achieved by halving the ladder—i.e. by removing the sliding extension from the main ladder.
- (b) The ladder should be first placed on the ground, the sliding extension uppermost. The method of halving is as follows: with the ladder lying on the ground, the ropes are uncoupled from the hooks or cleats, the pawls freed and the upper extension withdrawn. To reassemble, the upper extension is placed between the strings of the main ladder and pushed forward into its correct position; the ropes are reconnected to the cleats, pawls are placed in position on the lowest rung of the main ladder.

CHAPTER 13 DAMAGE TO BUILDINGS

Types of Buildings

Buildings can be grouped into categories by the methods and materials used in their construction. The main groups are as follows:

- (a) Unframed buildings
- (b) Partially framed buildings
- (c) Fully framed buildings
- (d) Monolithic buildings

Unframed Buildings (Load-bearing Walls)

The term unframed means that there is no skeleton of steel or reinforced concrete taking the load.

Partially Framed Buildings

Partially framed buildings characterise those which are halfway between unframed and fully framed, i.e. buildings containing a share of each. The external walls form the unframed section as they are load-bearing, and the framed section comprises the posts and beams erected to replace the load-bearing internal portions. Partially framed buildings of an old-fashioned type usually incorporate timber posts and beams, providing support for timber floors, or cast iron columns, moulded for strength and appearance, and beams of iron and timber or inverted tee section cast iron. In the more recent buildings of this type, however, the columns and beams are constructed of steel and are similar to those used in modern fully framed buildings.

Fully Framed Buildings

Fully framed buildings are so described because they have a skeleton frame which carries all the loads, including the weight of the walls. The frame may consist of steel, reinforced concrete or timber.

Foundations are usually formed individually for each stanchion, and may consist of comparatively small blocks of solid concrete, large reinforced concrete or steel joists encased in concrete. Where steel is employed steel joists are laid side by side, each layer running

at right angles to the one beneath and bolted together. This type of foundation is known as a grillage, to which the base plate of the stanchion is bolted. When the stanchions have been fixed the whole floor area is excavated and covered with solid concrete with or without steel reinforcing. The frame is formed by fixing the stanchions to their concrete bases, and fixing between them at suitable levels steel beams which will support the floors and transmit the load to the stanchions. These stanchions or beams may be encased in concrete or brickwork to protect the steel in case of fire. When the frame is of reinforced concrete steel rods will be incorporated in the concrete in place of steel stanchions and beams.

With a timber-framed building the foundations can be either concrete, stone, brick or timber. The external and internal linings are fastened to the load-bearing timber frame. The roof, which can be either gabled, flat or skillion, usually consists of tiles, corrugated iron or asbestos roofing.

Monolithic Buildings

Monolithic buildings, as the name implies, are built in one piece starting from the foundations, and these, the frames, walls and floors, staircases and roof are formed of reinforced concrete on the site as they occur in the building as it rises. The mass of reinforcing rods is carefully set out as each bar is hooked and wired in position, to form the raft or base of the building and partly up the walls and piers or columns. The timber formwork for the walls is then fixed in position, the steel reinforcement placed and the concrete poured over and worked around the bars. When the concrete is set the form-work is removed and the next stage proceeds, and so on upwards to the top of the roof, the floors being placed as the walls rise. The roof is constructed in the same manner as the rest of the building, and when the building is completed all the various elements are intimately linked together.

Depending on the type of construction almost all damaged buildings will contain voids or spaces in which trapped persons may remain alive for comparatively long periods. From a rescue point of view the cause of the damage is immaterial, but it is of vital importance that collapsed floor positions be studied and their value in relation to the extrication of casualties be appreciated.

Types of collapse

In the following paragraphs there are descriptions of various types of collapse. Each will vary according to the degree of damage; however, in the interest of safety to both the trapped and the rescuers, a thorough appreciation must be made before any rescue operation is commenced.

Some of the main considerations are—

- (a) Do not move any debris in contact with the collapse without assessing its value.
- (b) Provide tension struts between good walls and the leading edge of floors in the case of lean-to and braces between the two floor edges in the case of a 'V' collapse.
- (c) Always construct a dead shore before entering a void caused by horizontal collapse.
- (d) Always appreciate the forces and their possible direction of movement in all types of collapse.
- (e) Pack and support vertically, horizontally and laterally whenever and wherever possible.
- (f) In all materials used, consider their strength in relation to the loads to which they will be subjected.

All buildings when subjected to sufficient pressure will collapse in a manner which is largely dependent upon the type of construction, but in most instances the floors, ceilings and roof will collapse in large sections and not disintegrate into a large number of small segments.

These large sections when they fall must create voids, the most common of which are:

1. The 'V' type
2. The horizontal
3. The lean-to

The 'V' type collapse (Fig. 76) This can occur in any type of building but is more general in the unframed type and is caused by a heavy weight of debris such as roofing, ceilings, furniture, etc. falling on or near the centre of an upper floor or ceiling causing the joists to break and collapse in the form of a 'V', thus creating two voids in which casualties may be trapped.

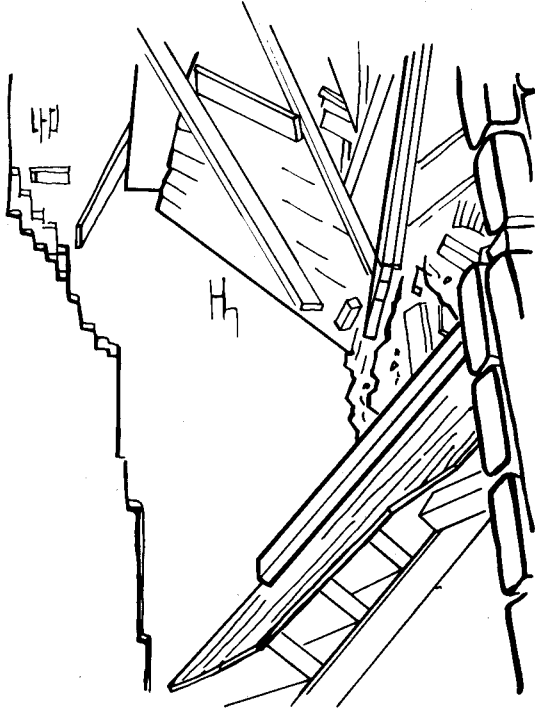

Figure 76. 'V' type Floor Collapse

The 'lean-to' collapse (Fig. 78) In many cases only one of the two load-bearing walls will collapse, and in this instance the upper floor or ceiling will 'hinge' on the remaining wall, thus creating the most common and the most difficult type of collapse with which to deal. Precautions must be taken at the earliest possible moment to prevent a complete collapse by tomming up or strutting.

The 'horizontal' collapse (Fig. 77) In some cases both load-bearing walls may be sufficiently damaged to permit the upper floor or floors, ceiling or roof to pancake down into the room below. This debris must inevitably land on furniture or some other obstruction, thus creating a void.

Reinforcing rods and fire-distorted structural steel may create difficult and hazardous rescue problems. However, these materials will create many safe places from which people may be rescued.

Rescue from framed structures may not be as difficult as from unframed, except for the fact that these buildings are usually large and multi-storied.

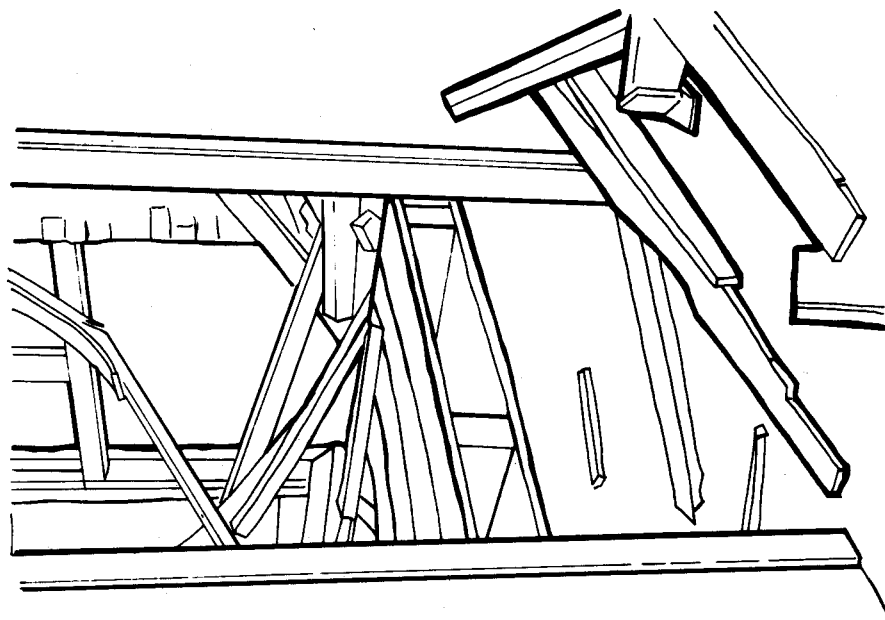

Figure 77. Horizontal Collapse

Hazards from Damaged Utilities

Any disaster will invariably result in ruptured electrical, water, gas and sewer lines and, although these will be primarily the responsibility

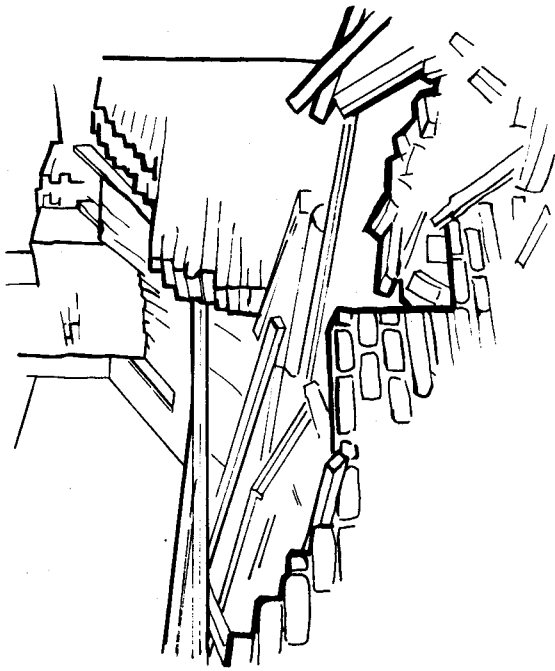

Figure 78. Lean-to Collapse

of the Engineer and Public Utility Service, it is essential that Rescue personnel be trained to deal with this problem in the initial stages.

Domestic Gas

Escaping gas in basements and confined areas creates danger of explosion and the following safety precautions must be observed:

- (a) Never look for a suspected gas leak with a match or other open flame.
- (b) Never attempt to ignite a gas leak. This is a job for an expert.
- (c) Never smoke in a confined space where gas may be present or is suspected.
- (d) Never use power tools or oxy-acetylene torches in a confined space where gas is suspected to be.
- (e) Always wear Remote or Self-Contained Breathing apparatus. The Service Respirator is NOT proof against domestic gas.

Electricity

Live wires present a serious hazard, both to trapped casualties and rescue personnel. The following safety precautions must be observed:

- (a) Assume all electric wires to be 'hot'.
- (b) Never attempt to move wires on the ground, dangling from poles or trees, or hanging slack between poles, except when a life is at stake and then wires should be moved with dry objects which are non-conductors of electricity, i.e. poles, boards or rope.
- (c) Avoid pools of water close to live wires—they may be just as dangerous as the wires. Avoid all other conductors, such as wire fences which may be in contact with high voltage wires.
- (d) Never attempt to cut high voltage wires or cables.
- (e) Insulated wire cutters carried are only fit for cutting wires carrying ordinary house current.
- (f) Be especially cautious at night when it is difficult to see wires.
- (g) Keep rescue trucks and other vehicles away from areas where wires are down.
- (h) The immediate action to be taken when approaching a damaged building is to locate the master switch, if possible, and switch off.

Water

Water from broken mains may flood basements and other places in which casualties may be trapped. The following precautions must be observed:

- (a) Always carry as part of the equipment the applicable water key for the locality.
- (b) Always carry portable pumping equipment to enable you to tackle the problem until the arrival of the Public Utility Section or Fire Services.

Sewers

Broken sewers may create problems of flooding and escaping gas. Sewer gases can be explosive as well as toxic. The following precautions should be observed:

- (a) Never use an open flame.
- (b) Always wear Remote or Self-Contained Breathing Apparatus.
- (c) Endeavour to divert flow away from rescue area by building a dam or other obstruction to the flow.