

Big Event Resources

The following sections will provide you and your team with resources and information that would be helpful in preparing for the Big Event. It would be wise to read through all of this information and to work as a team to use this information in preparation for the event. Doing this will give you the edge on those who have not taken the time to prepare and will make the event a highlight of your scouting experiences.

Moccasins

The standard footwear for the American Indian and the Mountain Man was Moccasins. Many of the mountain men who came west with boots soon learned how much more convenient it was to have and wear moccasins like the Indians. They were much more practical and easy to make to replace worn out boots. These moccasins had to be made as they were not available in a local shoe store to purchase.

Each Indian tribe had their own unique style and way to make moccasins. The patterns were so representative that a man could tell what tribe of Indians he was looking at by the shoe they wore. There are many different styles of moccasins and many different books and methods of construction. The Plains type was made of one piece. The Woodland was made with a “vamp”. The Apache even had a hardsole type and one that went up to the knee. Indians decorated their moccasins with beadwork, porcupine quills and paint.

Moccasins are fun to make and comfortable to wear. This is excellent footwear suited for camping, and stalking deer or other game. Each of the different types of moccasins are suited for different types of terrain. Decide which style you prefer to make before you cut the leather. It is best to make your pattern from butcher paper or out of a brown paper sack. Assembling this pattern will ensure that your finished moccasin will be a good fit. Each person’s feet are different and moccasin making is great because it is custom fitted by each individual making their own footwear. The following illustrations will show the types and styles which can get you started on a project. There are also several moccasin kits available from craft stores, leather stores or Indian shops.

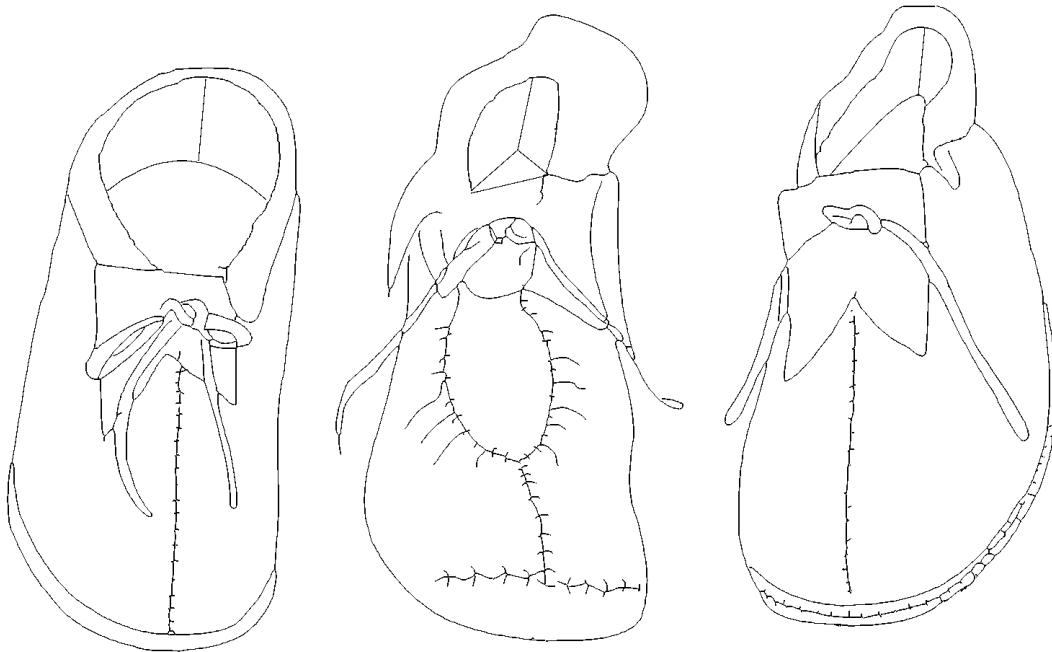

PLAINS

WOODLAND

HARDSOLE

Sample Moccasin Patterns:

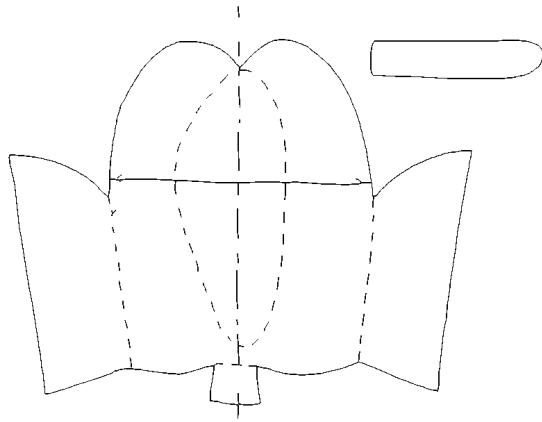

Woodland One-Piece Soft-Soled

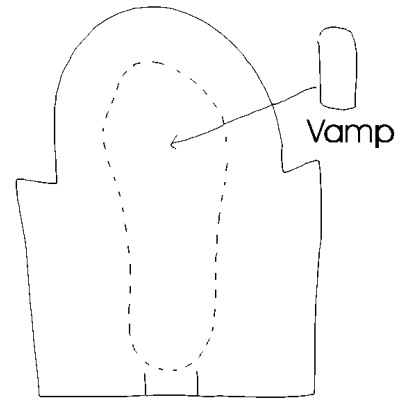

Woodland Pucker Toe

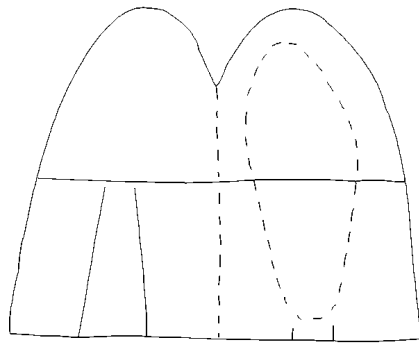

Plains One-Piece with Long Tongue

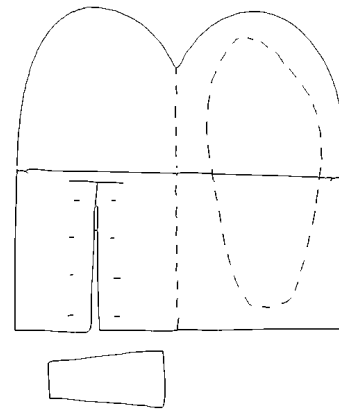

Plains One-Piece with Separate Tongue

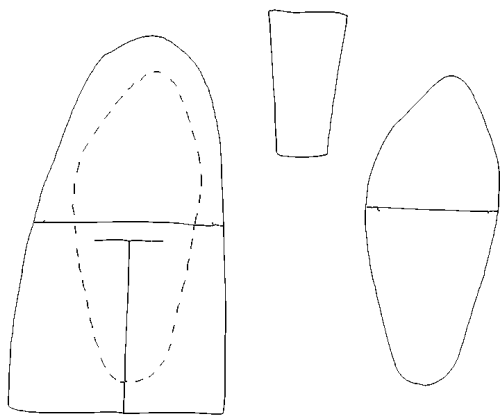

Plains Two-Piece Hard-Soled

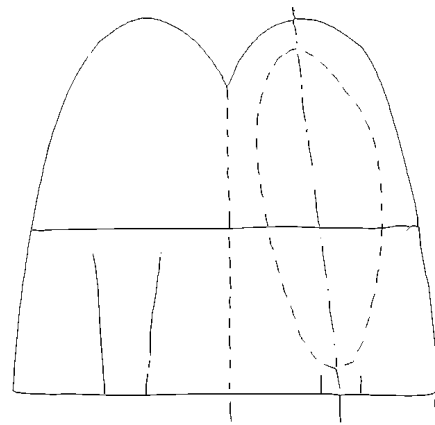

Plains One-Piece Soft-Soled

Pouches and Bags

Traditionally the Mountain Man did not have pockets in their buckskin pants, thus the need to have some way to carry and hold items that would normally be carried in the pants pockets. A possible bag is used to carry anything and everything that you need to have immediately available to you. Possible bags vary greatly in size but are usually around 10 inches square. They usually have a long strap which can be put around your neck and on a shoulder to carry them so the bag hangs close to the belt line. Things today that you might want to carry in a possible bag are keys, paper, pencil, cash, wallet, or even black powder supplies.

A smaller pouch called a medicine pouch was often worn by the Indians and mountain man as well. This pouch is usually about 3 inches square and hangs around the neck. Although by definition these bags contained medicines (usually of natural herbs and plants), it was probably more commonly used to contain "spiritual" medicines for the soul. These medicines might include a piece of hair from the tail of their favorite horse, or a bit of ashes from a sacred campfire that they had attended. Today it can be used in a similar way so that you can always remember your outings by carrying a small piece (ashes, dirt, etc.) from these special occasions. The medicine pouch is considered to be sacred to its owner and should never be opened by others.

Another type of pouch used by the Mountain Man is the Strike-a-Light pouch. These come in a wide variety of shapes and sizes and are used to contain fire starting equipment and supplies. These pouches are normally connected to your belt and hang on your waist.

Other bags made by the mountain man include pipe bags and shooting bags. Modern day versions might include a cell phone or radio pouch or an ammunition pouch.

The following pictures show different types of design ideas, shapes and sizes of pouches. These are easy to make and can be very inexpensive. The smaller pouches can be made from small scrap leather pieces. Most tanneries will sell scrap at a reduced rate. You can also find leather purses and jackets (from which to make pouches) at your local thrift stores. Even traditional purses can be recovered to render great pouches. Pouches can also be made from old jeans or other heavy cloth materials. Use your imagination and have some fun.

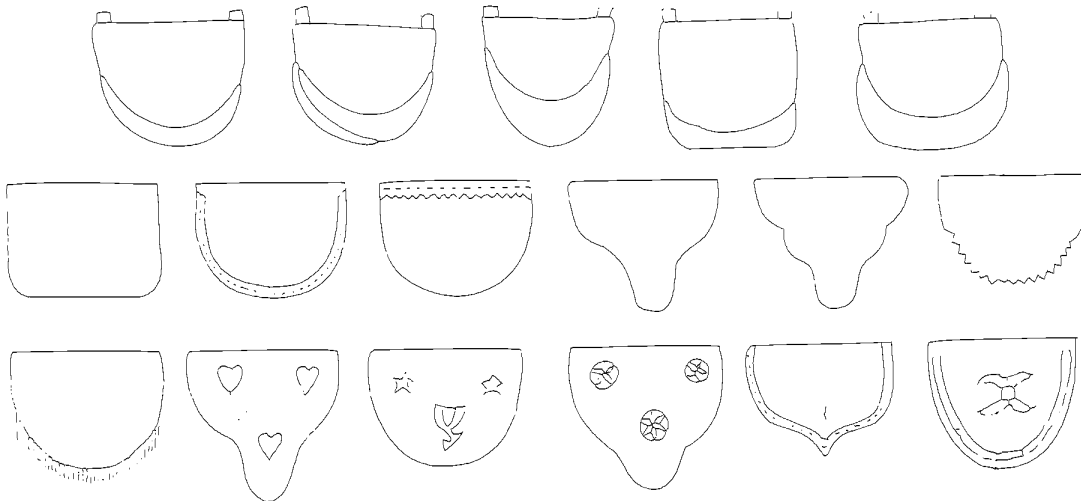

Medicine Pouch Patterns

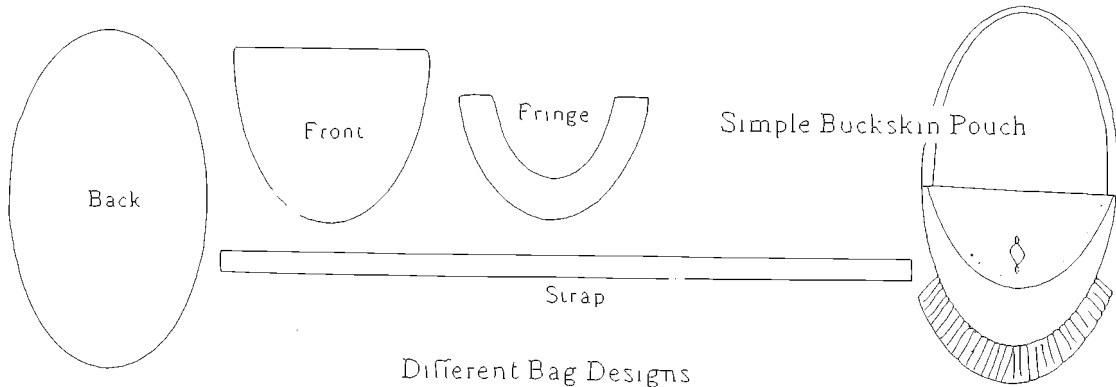
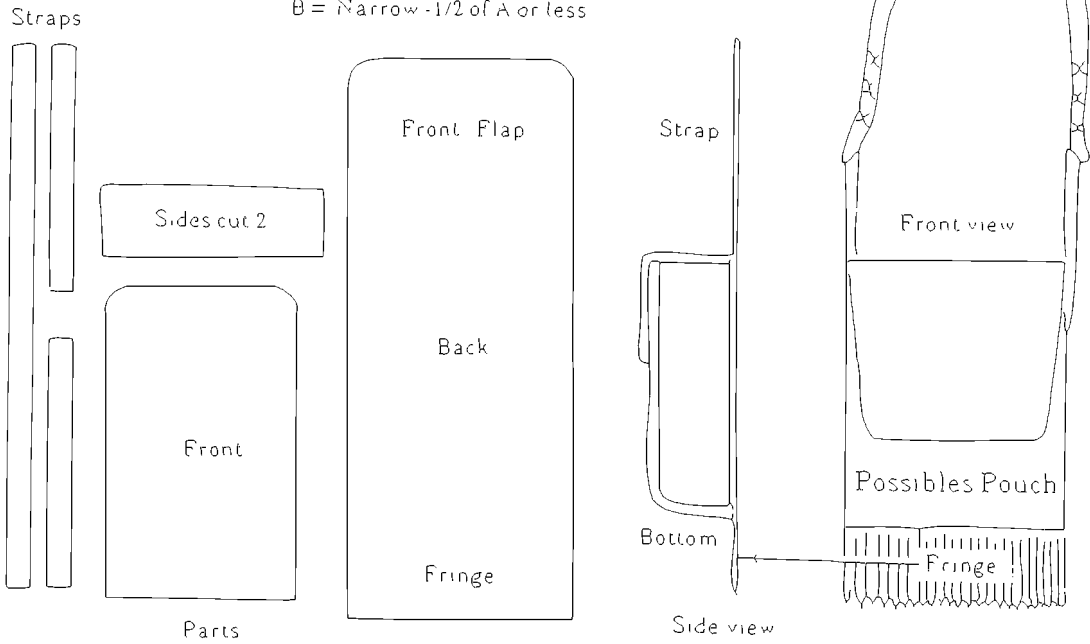
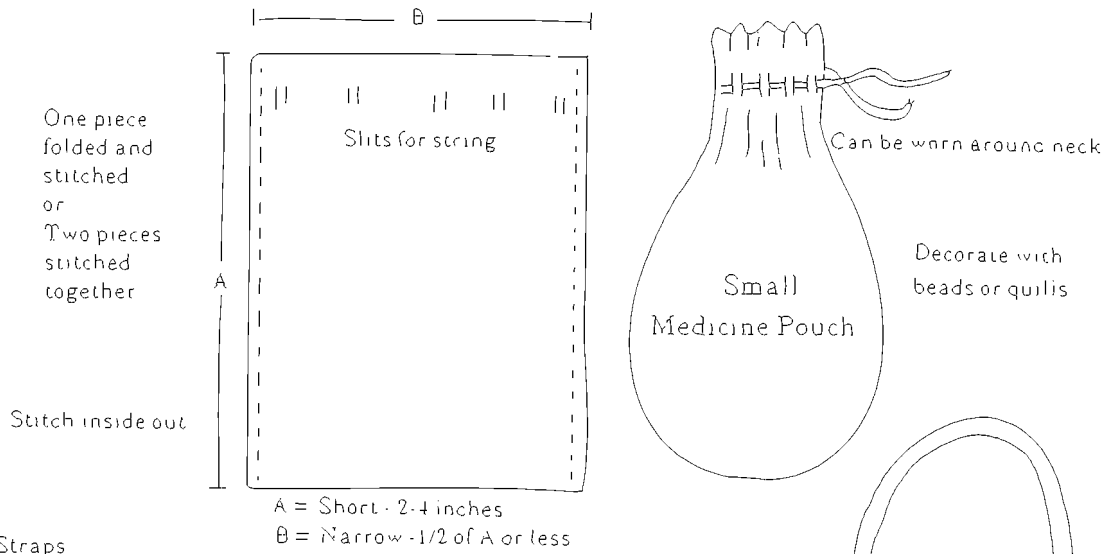

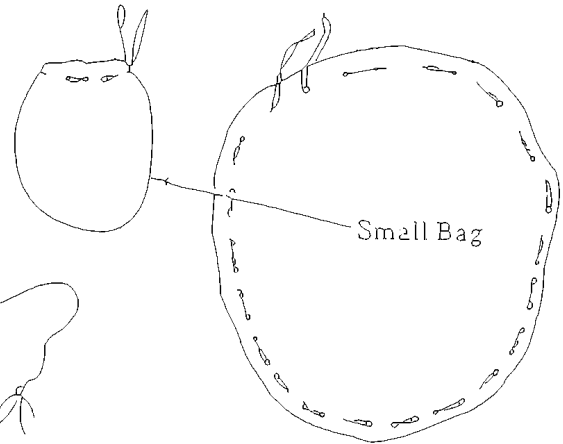
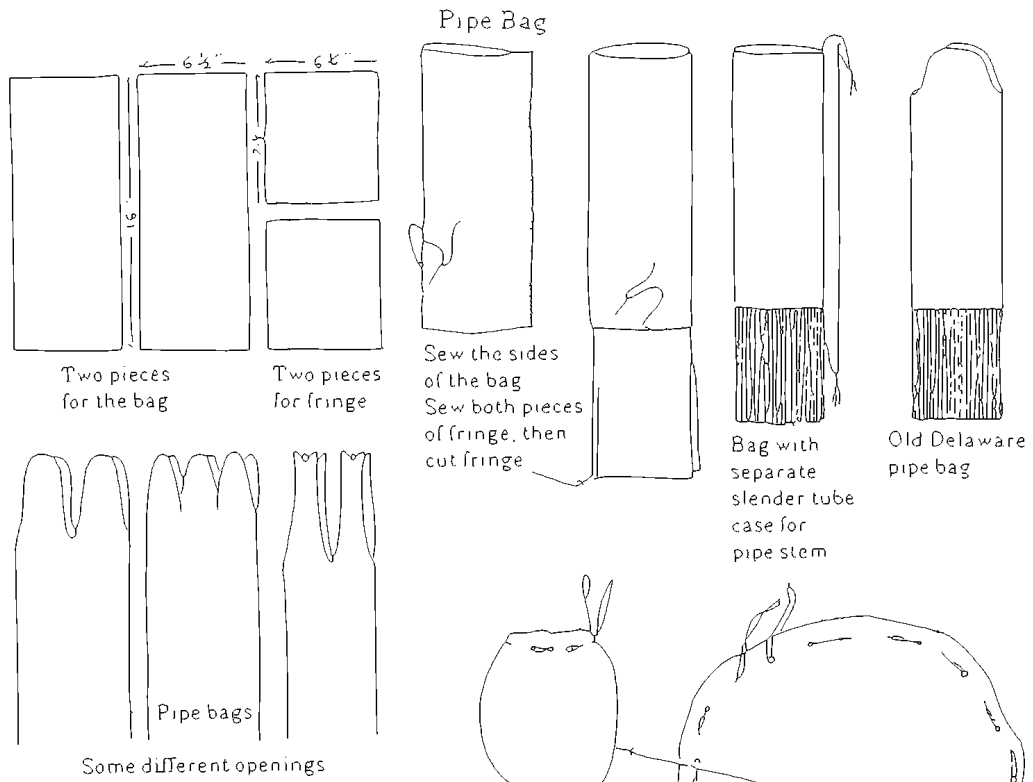

Simple one piece bag with draw string
Good for holding beads and other small objects

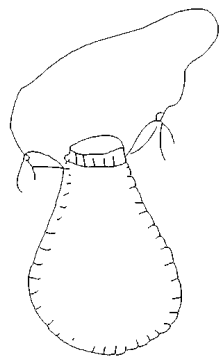
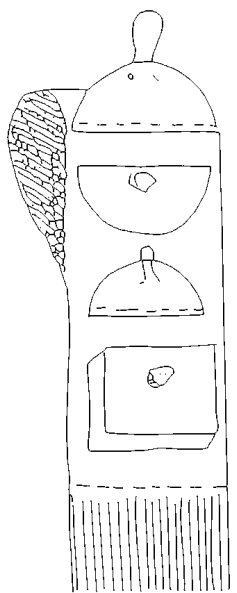

Bags can be decorated with beads tin cones, fringe, bones, feathers and many different things

Pockets can be added to the design of the inside to hold special items

Different Bag Designs (cont)

Capotes

The fur traders made use of the natural repellency and warmth of wool blankets by making Capotes. A capote is a hooded overgarment or coat. Capote is an anglicized version of a French word meaning "Cape Cod Coat". It dates back to the early 1700's. There are also many period drawings of soldiers wearing them in early American history. They came from the early French influence on trade of Northern England and Canada. This coat, used by Indians and Mountain Men, made use of colorful and functional wool blankets to keep warm and take the chill out of low winter temperatures. It was even worn at night as sleeping bags had not yet been invented. Most of the capotes had a hood that could be pulled over the head in cold weather. They were also water resistant to light snow or rain. They can be used as a coat or as an extra blanket in cold weather. Because of these reasons, the capote became an important part of the clothing used during the fur trapping era.

The capote is relatively easy to make once you get past the fear of cutting into an expensive wool blanket. The main materials needed are a 72 x 90 inches of a wool blanket. Note that larger men may require larger blankets. Wool is recommended as the newer man-made fibers are not as warm and do not repel water as well. The traditional capote was made from Hudson Bay or Whitney blankets. These blankets today sell for 60 to 150 dollars and up. For a less expensive capote there are many options available including thrift and discount stores and military surplus stores. Patterns are available from Indian and mountain man craft stores. The Eagle View patterns are good ones to use but there are probably many other patterns available as well.

Here's some simple directions for making your own capote:

First, make a pattern from some wrapping paper. Measure your arm length from the top of your shoulder to the wrist, adding an extra inch. Measure the length of the coat body from the back of your neck to whatever length you desire; preferably a little past the kneecap. Most Hudson Bay blankets are 72 x 90 inches, so keep that in mind when laying out your pattern. See diagram 5 for remaining measurements. (Helpful hint: You may want to use an old coat as a pattern. Remove the threading from the seams and take the coat apart completely.)

Remember that the body of the capote is made from one piece of cloth. When you think you have all the pieces you need, lay them all on heavy wrapping paper and trace around each piece. Mark the items "left arm," "right arm," etc. Cut out each piece with scissors.

Construct the capote by putting all the pieces together with pins or tape. Follow diagram 5 closely. When you have satisfied yourself with a decent fit, you are ready to cut the actual pattern out of the blanket.

When laying the pattern onto the blanket, make certain that the colorful stripes are all going in the right direction. Also, lay the paper pattern onto a lightweight, inexpensive fabric, and cut out the pieces. This fabric can be sewn together like a lining and later used as such, and you'll probably end up getting a better fit. When hand sewing, follow the sketch and use red wool yarn for sewing pieces together and for the edging. The last piece is simple. Cut a belt to circle your waist with enough left to hang over. It should be about 3 inches in width. You now have a nice warm Lone Hawk capote.

Capote Pattern:

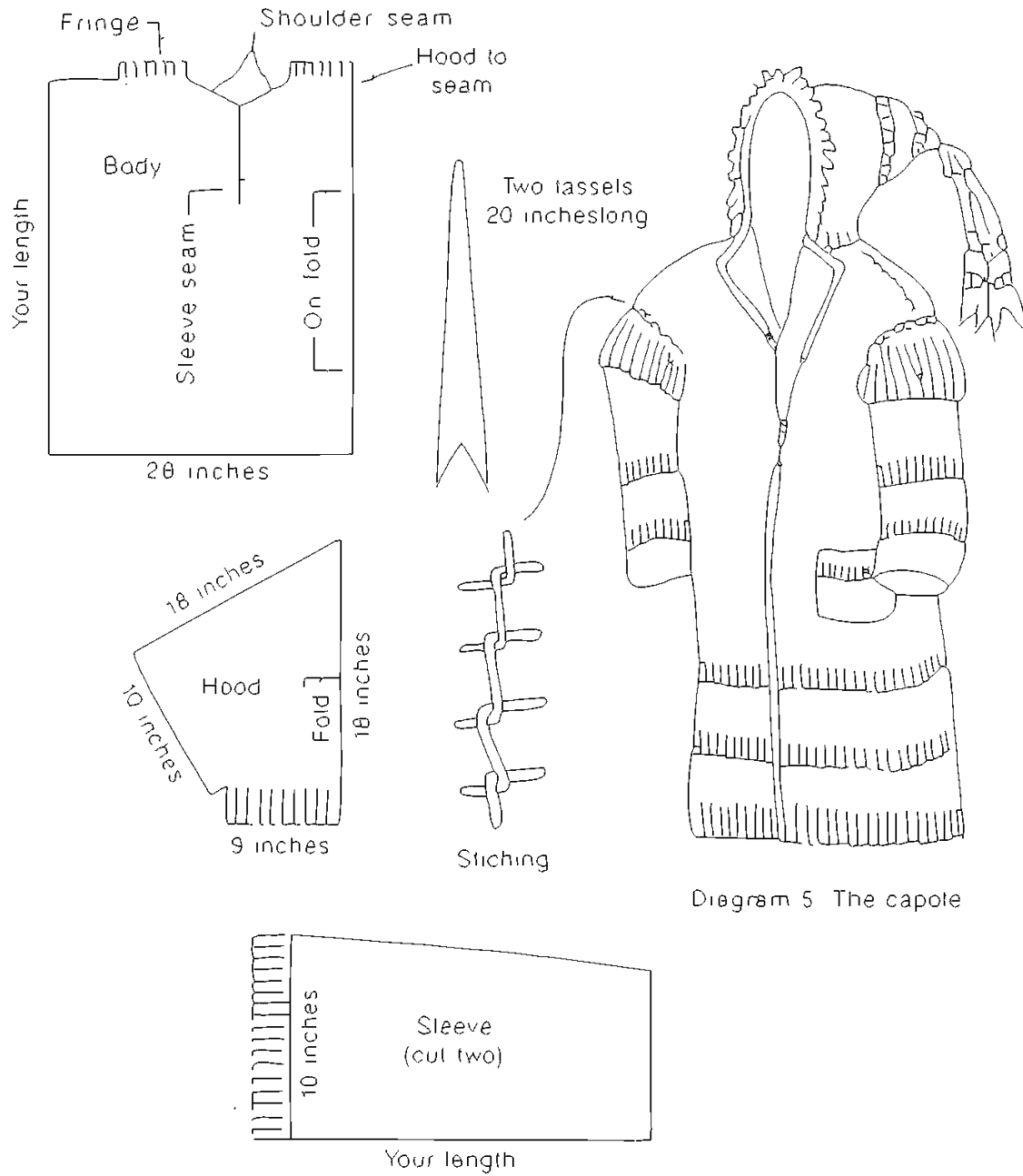

Diagram 5 The capote

Period Hats

Each mountain man had a hat of his own that might have been of a standard shape, but over time had been customized for them. Each mountain man had a unique hat which made them recognizable from quite a distance. Here are some of the basic types of hats used during the mountain man era:



Crooked hat

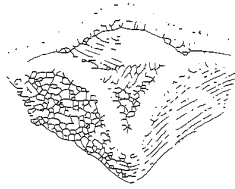

Tricorn hat

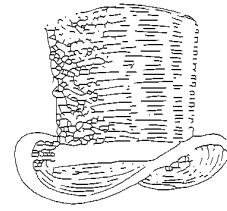

Beau Brummell or Top hat
(made from beaver)

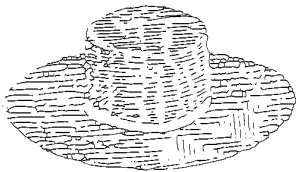

Broad Brimmed Beaver hat
(known as the Bridger)

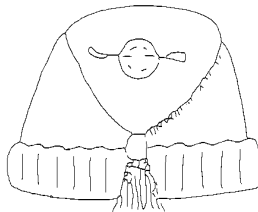

French Trappers or Voyager hat
(knited wool yarn)

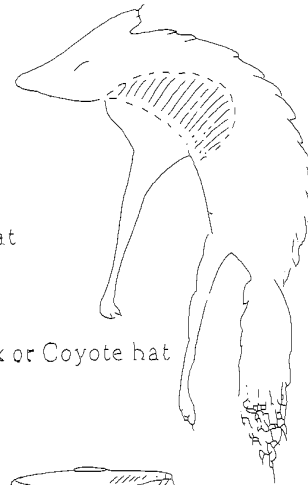

Fox or Coyote hat



Coon Skin cap

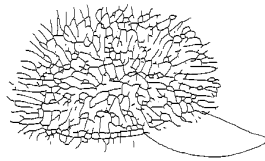

Fur Hat with leather brim

Regular Felt hat

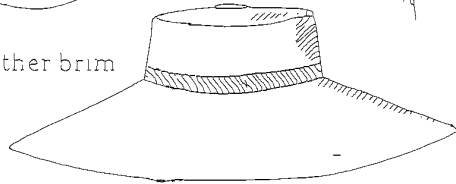

Shirts



Capea Woodsman's Frock

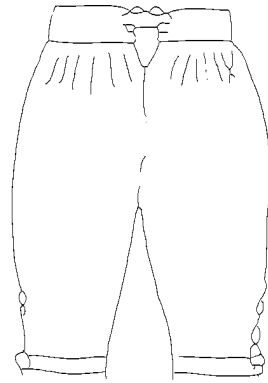

Broadfall Drop Front Breeches

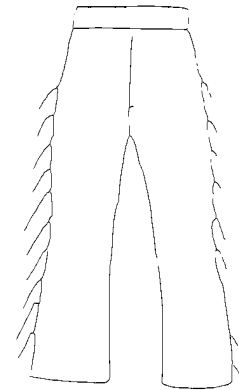

Early Frontiersman's
Leather Pants

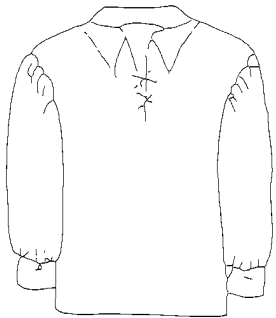

Early Drop Sleeve Shirt

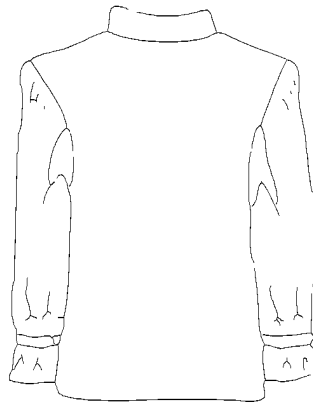

Authentic American Shirt

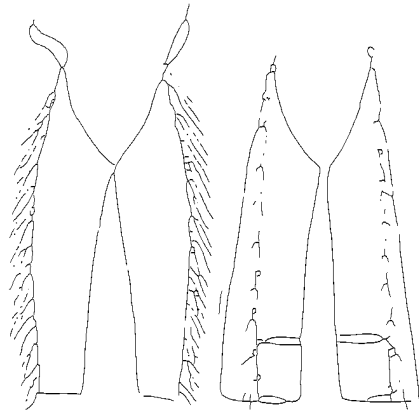

Leggings

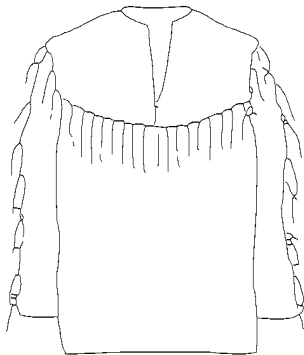

Early Frontiersman's Shirt

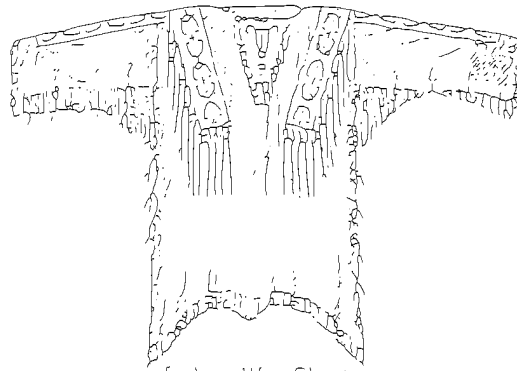

Indian War Shirt



Breechclout



Frontiersman's Shirt



Period Clothing

Pants

The mountain man pants were traditionally made from buckskin leather. They had button down flys but no pockets. A breachcloth was also worn in conjunction with these pants. Today buckskin can be very expensive to buy, especially for varsity age youth. One solution to this is to get raw animal skins and learn tanning so that you can make your own buckskin and use that material for pants, jackets and shirts. Another option is to make pants from other materials such as canvas or heavy cloth. You can easily make a pattern by taking an old pair of blue jeans (that fit already!) and cut them down the seams. Add just a little bit to this size for the new seams and use this as a pattern. Using this method pants can be made very quickly in one or two team meetings.

Knives

Throwing Knife

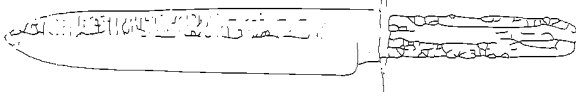

Patch Knives



Fighting Knife (Bowie)

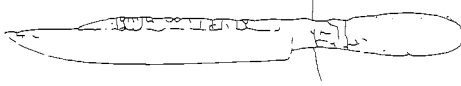

Famous Green River Knives

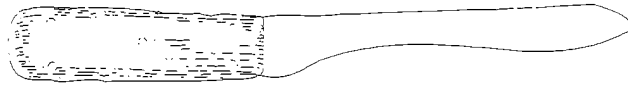
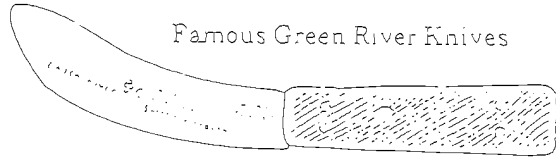

Utility Knives

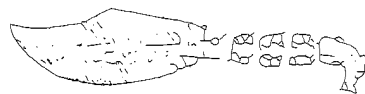
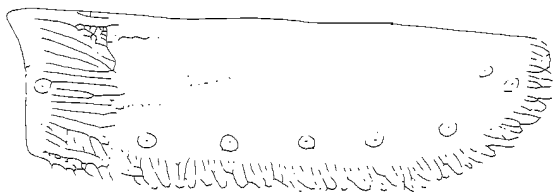
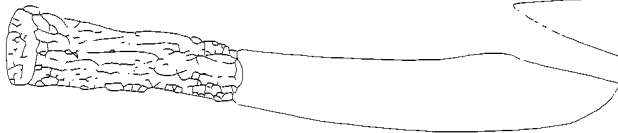
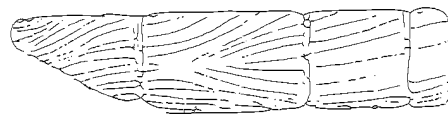
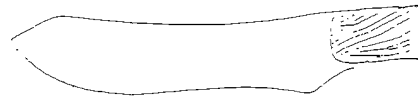
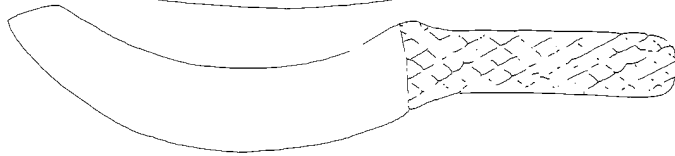
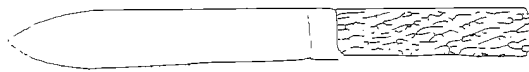
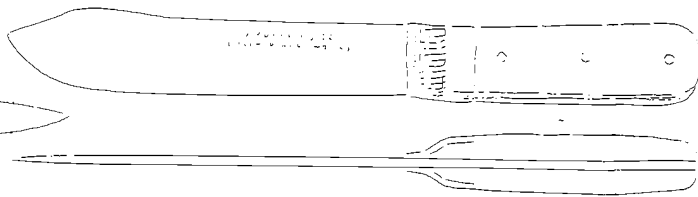
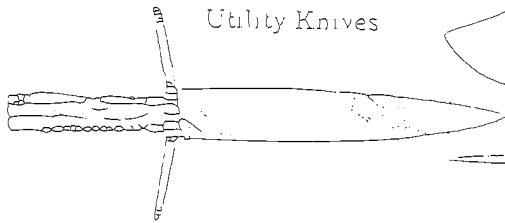

Tomahawks

One of the activities that is commonly done at rendezvous is the throwing of hawks and knives. To assist you in preparing for this type of activity the following information is included.

A Basic Manual on Tomahawk Throwing

by R. E. Valade with illustrations by E. J. Valade

People familiar with tomahawks and their use often refer to them as "hawks". Similarly, terms like pipe-tomahawk have been shortened to pipe-hawk. Tomahawk targets frames are usually called hawk-boards or hawk-blocks.

The average tomahawk has a blade up to 4 inches wide at the cutting edge and a handle from 14 to 20 inches long. Weights run from half a pound to three pounds. The average throwing hawk weighs a little less than two pounds. A forged blade is preferred as it can be readily sharpened with a file and will take considerable abuse without breaking. Handles, however, are not as forgiving and should be considered, at least to some extent, expendable items. This is especially true during the learning period. The sides of the handle should be thinner. This helps in holding the hawk straight and in grasping it the same way every time. The handles on most good quality hawks are a drive fit down through the eye of the blade. The handle, therefore, should also be tapered to some degree. Some hawks are drilled and a pin is driven through the eye of the blade and the handle. This often tends to weaken the handle and encourage splitting. The best way to install a handle to a blade is to make sure the wood of the handle is as dry as possible when they are driven together. Normal moisture will cause the wood to swell slightly to make the fit all the more snug. The blade does tend to slide down the handle from time to time through usage. This usually occurs when the handle end of the hawk strikes the target first. When this happens, merely drive the blade back on the handle until it is snug again.

It is strongly recommended that if one happens to be fortunate enough to own a good pipe-hawk or other ceremonial type hawk, he refrain from throwing it for fear of damaging the frail, hollow or decorative handle.

Since most hawk throwing is done at a minimum distance of 12 feet, measure off that distance from a suitable target and then take one full step back.

Stance

The suggested stance is feet comfortable side by side. The weight should be shifted to the right foot, assuming you're right handed, just before throwing. At the same time as the swing of the throwing arm, step forward with the left leg. The action of the feet is not unfamiliar to that of a man throwing a ball. Some people find it more natural to reverse the footwork and step forward with the right leg. Choose whichever is more comfortable and natural to you.

Grip and Release

Take hold of your tomahawk as you would hold a tack hammer. The thumb should be at the side of the handle while the fingers are wrapped around the handle. (See Fig. 2) Point the hawk, cutting edge down, and the throwing arm fully extended towards the target. The throwing arm is then raised over the shoulder without fully bending the elbow. When the arm is brought down to a near horizontal position, (see Fig. 3) the fingers are opened for the release. At the moment of release, when the fingers are opened, the position of the hand is similar to the appearance of a hand being offered in a handshake. Be careful not to twist the wrist as this will make the hawk go somewhat sideways. Use mostly arm motion and a minimum of wrist action. Don't try to throw too hard. The average hawk, if sharp, will almost stick of it's own weight. Power, speed and more important, accuracy will come with time and practice.

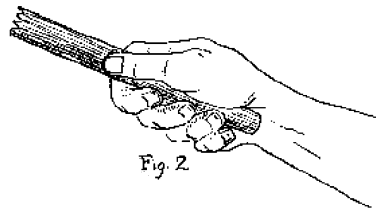



Making the Hawk Stick

Even if you're using a hawk with a spike, (see Fig. 4) we're only concerned with making the cutting edge stick in the target. If after throwing your hawk a half way each time, you can't get it to the hawk strikes the target first dozen times, the exact same stick, notice what part of the head of the hawk hits first, you are probably using too much wrist action. Try again releasing a little earlier and controlling your wrist action more. If the handle hits first, throw again in exactly the same way except back up six inches to a foot at a time until you get "blade" in the block. Once you get your distance, measure it and pace it off. Remember that distance. it is your "standard" throwing distance. Practice at that distance until you can consistently get at least ten throws in a row to stick in the block. Now you'll be looking for accuracy. From this point on it's practice and more practice.

Variations

Once you get your "standard" throw down pat, you will want to experiment with variations of the basic throw. The standard throw causes the tomahawk to make one full revolution. By backing up about 9 or so feet, you can get the hawk to make two full turns and stick. By backing up about 5 feet from your standard distance, and holding the hawk cutting edge up, you can get your hawk to make one and a half turns and stick with the handle pointing up. As with your standard throw, you will have to experiment a bit to find your particular proper distances. As you get more and more proficient through practice, you will find that your distances no longer need be so exact as you will have developed better control of your throwing technique. Remember, it is more important to be very good at one distance than to be just fair at many distances.

You will want to be able to throw your hawk at a run. In doing so, try to run by your target rather than towards it. In doing so, your distance from the target will remain more constant. If necessary, run towards the target then cut to your left and throw to the side rather than to the front. Try to maintain as close as you can to your standard distance while running by the target. Here again, success follows practice.

Targets

A slice of soft wood one foot or more in diameter and 4 inches or so thick makes an excellent hawk-board. Bore 3 holes as illustrated to make a tripod stand. Use 2 inch diameter legs. The center of the slice should be about 4 feet from the ground. A soft wood log one foot or so in diameter and six or seven feet long makes a good target also. The log should be buried a foot or so deep should be blazed to form a flat target area. The log can be braced, if necessary.

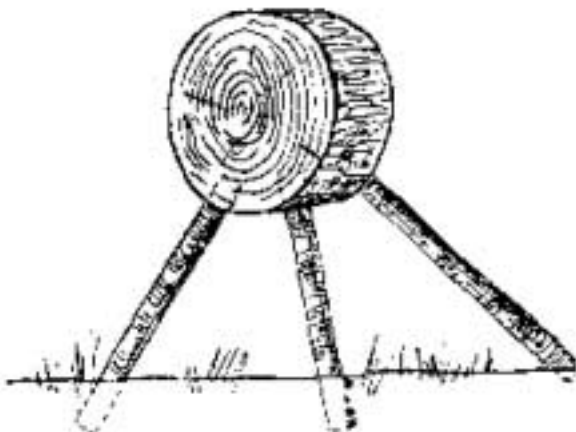

A more formal target can be made by using 6 x 6's. Two 4 footers and two 8 footers are bolted together using half inch threaded rod. The rod ends are counter bored so that no metal is exposed. The long pieces are buried about 2 feet deep. It is considered a bad practice to throw at live trees as the cuts in the tree can cause a heavy sap loss which can kill the tree. Targets for an informal match or for practice purposes can be anything from a playing card to a piece of paper or bark stuck in the log. Scoring can be improvised accordingly.

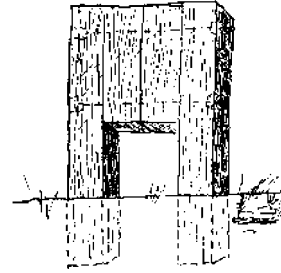

Fig. 5

Handles

Should replacement of a broken or split handle be necessary the choice of wood should be Hickory or Ash, in that order. Both woods are strong and springy. Oak and Birch are strong enough but don't have the "give" that is necessary for a good hawk handle. Maple makes a good decorative and ceremonial handle. Soft woods should be avoided except for temporary emergency purposes. The grain of the wood should run from poll to blade. The cross-section of the handle at the eye of the hawk should be tear-drop shaped so that it fits snugly into the eye of the hawk. (See Fig. 5) The cross-section at the bottom should be egg-shaped with the smaller diameter at the front. (See Fig. 6) This shape is conducive to a strong and comfortable handle. The length can run from 14 to 20 inches depending on the size of the head. The taper should be very gradual from top to bottom. Don't make your handle too smooth, this tends to make the handle slippery and hard to handle in wet weather. By the same token, don't leave it so rough as to get splinters in your hand. A good oil stain is all that is necessary to finish a functional tomahawk.

Uses

The type hawk I personally prefer and use is the forged type offered on the market as the "squaw-hawk". It has a 15 inch handle and a total weight of 3/4 pound. This hawk, because of its weight and size is an excellent one to carry. It is nowhere near as cumbersome as the larger ones and it can be thrown all day without "throwing your arm out".

As a man is familiar with the possibilities of his rifle, so should he be familiar with the possibilities of his tomahawk. It is a tool and he should seek as many uses as he can for it. If kept properly sharpened, one can easily field dress and skin a big game animal with a hawk. The pelvic bone problem is solved with a flip of the wrist. In skinning, a natural for the hawk, the poll is held in the hand with the handle sticking out on side or the other. (See Fig. 7) It's obvious use as a hatchet for chopping or splitting wood needs no explanation. The poll can be used, to some degree, as a hammer. My hawk poll is kept somewhat flat for that purpose. If you have a spike-hawk, you have a built-in pick. Of course, any hawk can be used as a digging tool in an emergency. Hawks have even been used as paddles. The many uses of the tomahawk are limited only to the user's imagination.

Hawks Used by the Mountain Man

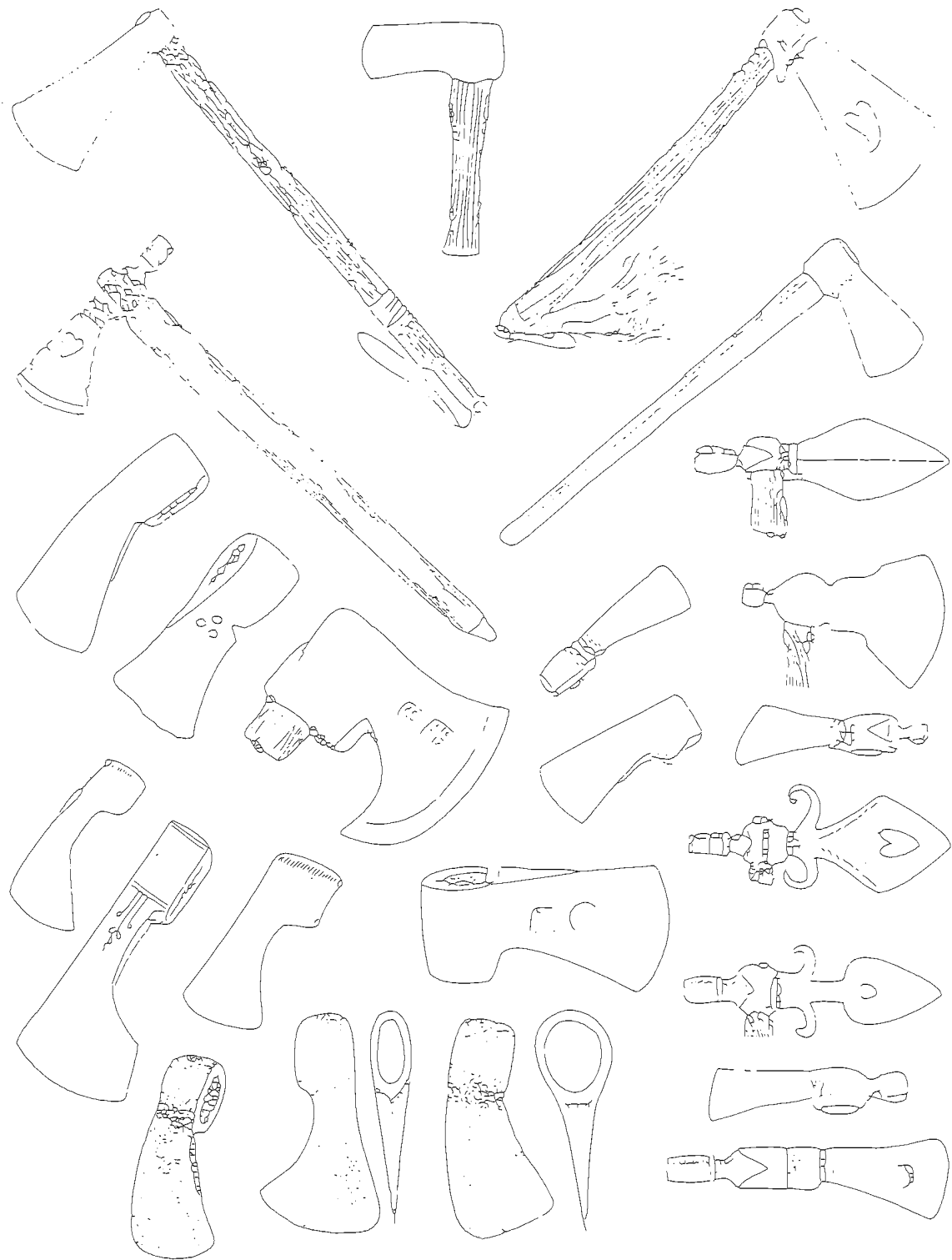

Traps and Trapping

Common beaver traps used during the mountain man era:

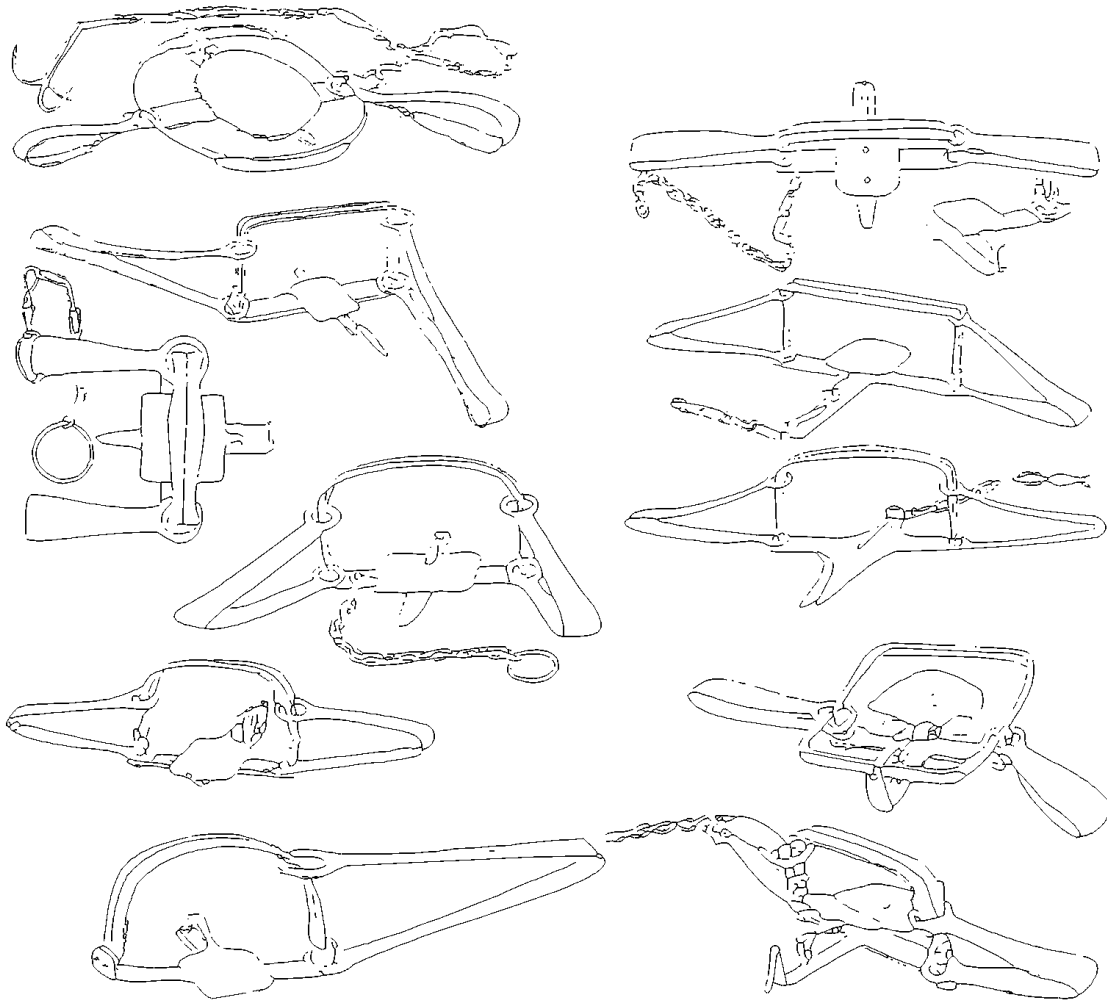

Parts of a Beaver Trap

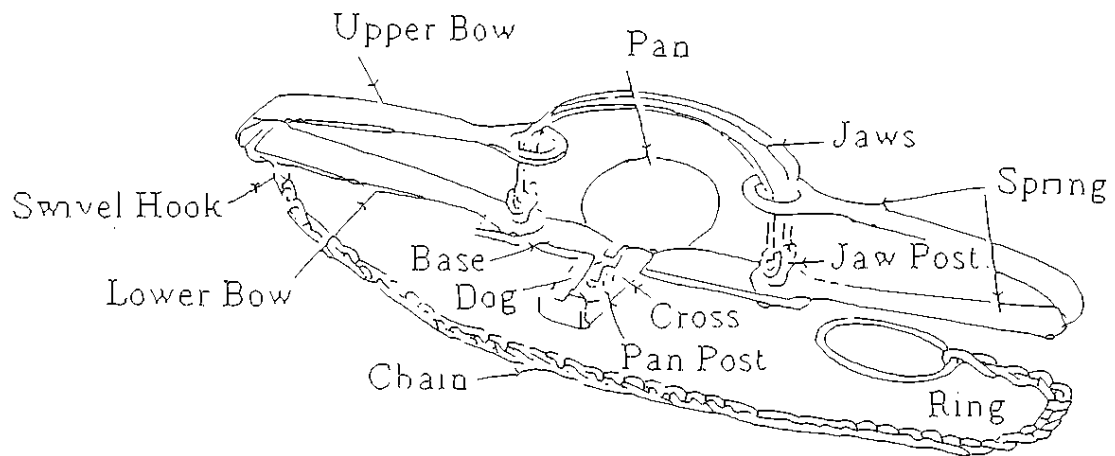

Firemaking

There are several methods of making fire that were used by the Indians and the mountain man. Among the most common are flint and steel and the bow drill. Both methods require just a few simple tools which can be easily made.

To make a flint and steel kit, first make the striker by using an old file. Forge (heat and bend with hammer) the material to get it to the desired shape. Heat it until it is red-hot in the center. Cool the material by immersing it in water. Use an old tin box of any kind to pack it in. A common shape for strikers is shown below:

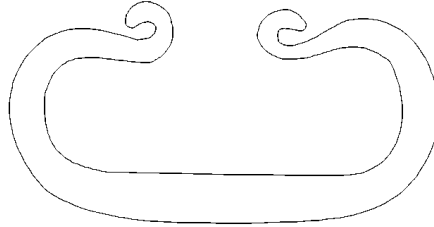

You will also need char-cloth. This cloth is used to catch the sparks from the striker hitting a flint stone and allow the sparks to ignite the cloth easily. To make char-cloth, first you'll need cloth you can burn. Sheet material is a good choice. It should be 100 percent cotton and not a blend with synthetic fibers. Cut the cloth into small patches about 2 inches square. Place the pieces in a small, airtight metal can with a small nail hole in the top. (You're right, it is no longer airtight with the hole in it.) It must be tight enough so that the cloth does not burn. Throw the can into the fire. A faint wisp of smoke coming from the nail hole indicates that the cloth is charring. The cloth should be dark brown to black when it is charred.

Flint rocks are easy to find in most areas. Try to find one with sharp edges as they will work best against the striker. Once you have all these items, make a small leather pouch (strike-a-light pouch), bag or container to carry it in. To start a fire you will need to build a "birds nest" of pine needles or other easily flammable materials. Place a piece or two of char-cloth in the center of your birds nest and position this under your flint stone. Curling the striker around your fingers bring it down firmly against the edge of the stone quickly. The stone will put off hot sparks downward which you should try to catch in the char-cloth in your birds nest. Once a spark hits the char cloth it will cause a slight glow. Gently blow on the glow until it increases to a full flame. You should have tinder ready in a fire pit to put the birds nest into and from there you can build up your fire. With a little practice you should be able to start a fire in less than 30 seconds with three or four good strikes.

If you are unable to find or make a striker an old file just as it is will make an excellent spark. The blade of a knife will also work if it is made of High Carbon Steel, **NOT** Stainless

Lodges

Many different styles of lodging were used by the mountain man but most of it was quick to setup and easy to move. Here are some of the more common styles used:

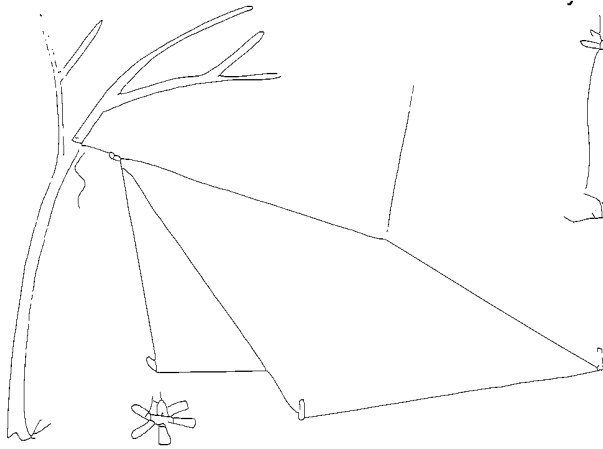

Diamond lean-to shelter

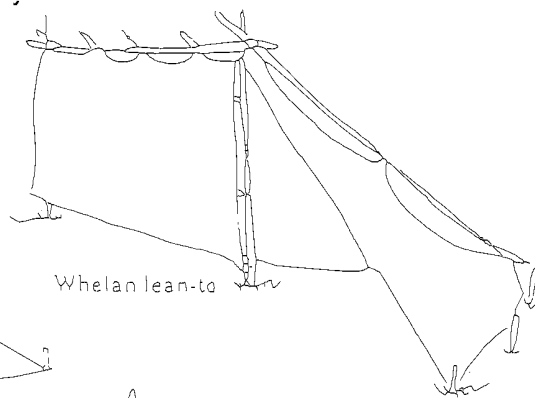

Whelan lean-to

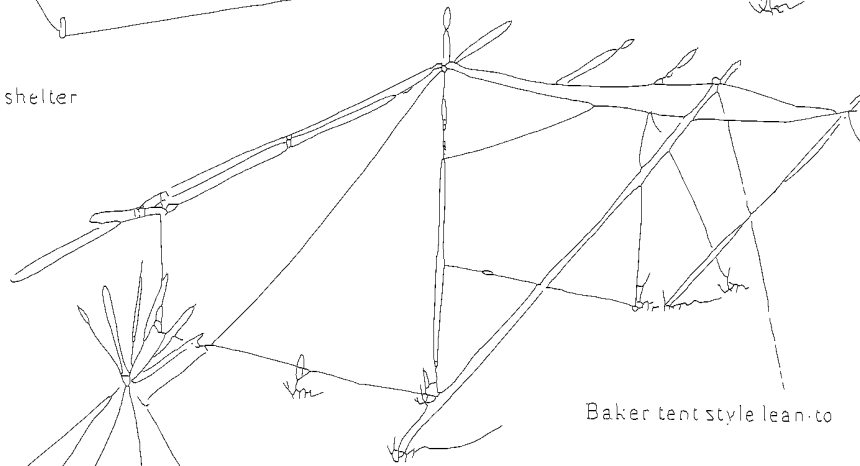

Baker tent style lean-to

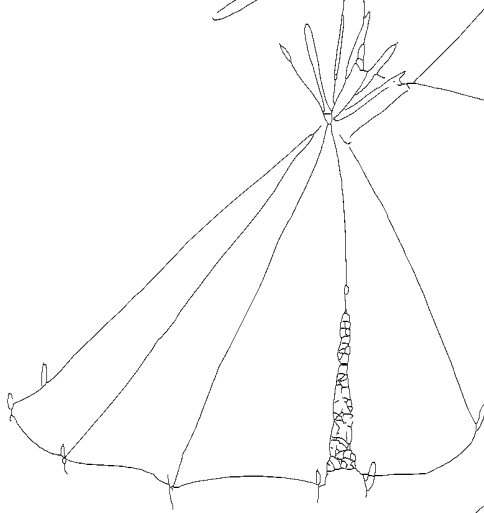

Multi pole lean-to or ti-to

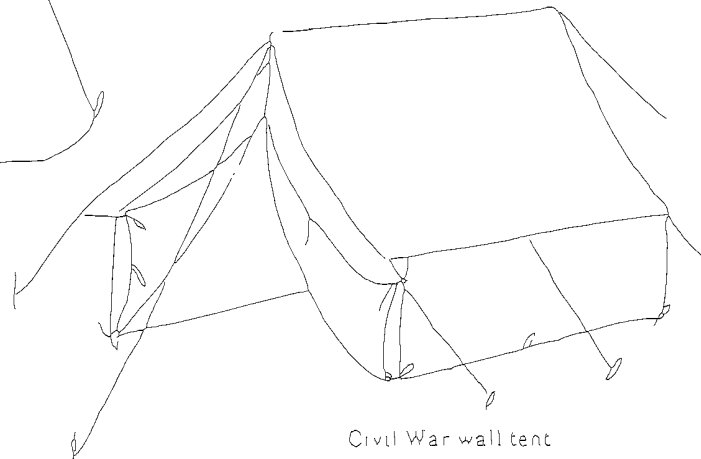

Civil War wall tent

Black Powder

Black Powder and Muzzleloading has always been a part of the mountain man legacy. At a rendezvous, black powder competitions are almost always present. Here is some information on black powder that might be useful to you.

Samples of Black Powder guns used by the mountain man:

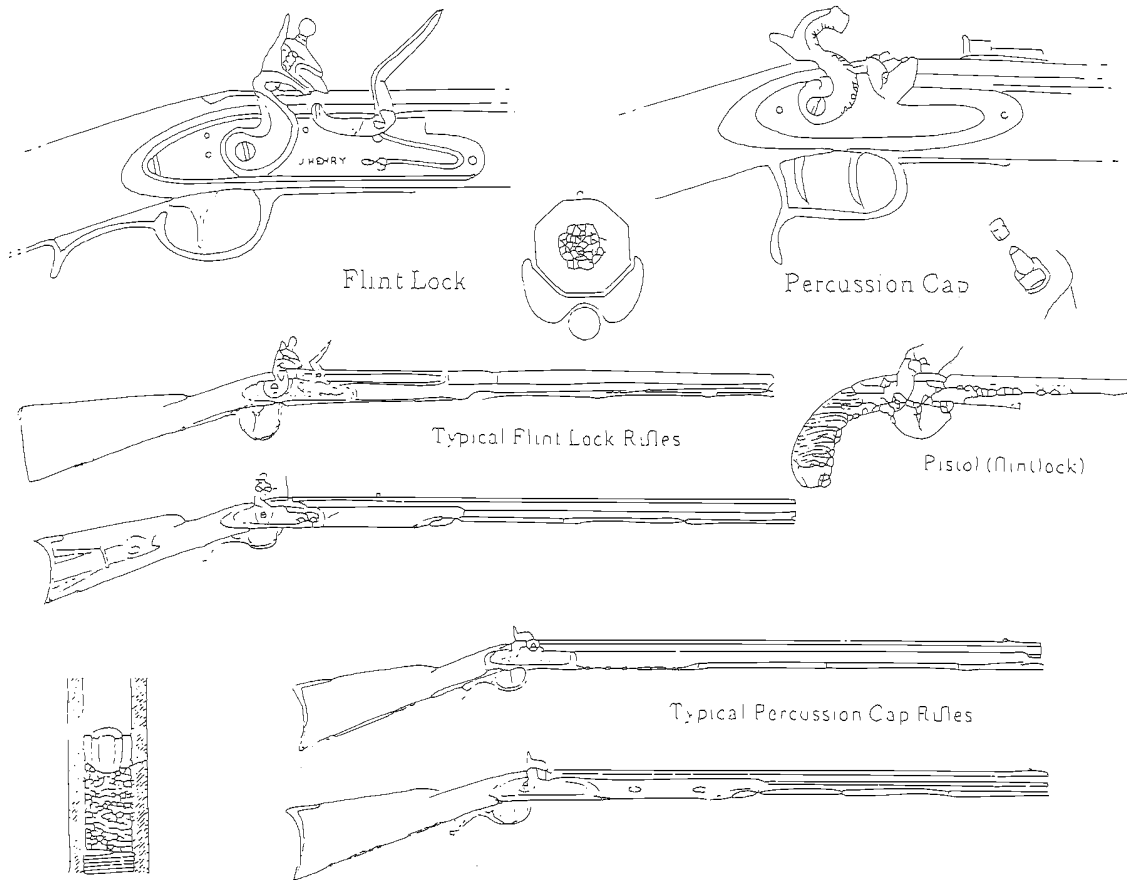

BSA Policy requires that an NRA certified range instructor be present when Scouts are shooting

Let's start with target shooting, we'll cover hunting in another article. Now the objective to target shooting is to produce the tightest group possible. Notice I said group and I did not mention score. You tighten up the group and the score will come with it. In fact there is a primitive match where the winner is determined by the tightest group

There are four components to every black powder load, the powder, the patch, the lubricant and the ball. Varying any one of these can greatly affect your group. Let's assume that you have a new .50 caliber percussion rifle. You've picked this rifle because the caliber is suitable for target shooting, plinking and hunting deer sized animals. Your first decision is what caliber ball to pick. With a modern gun the manufacturer will usually recommend a caliber. This is a good place to start. With a custom gun or such, measure the bore with a caliper and select a caliber about .005" less than the bore measurement.

Now I am assuming that you already have a safe place to shoot, a comfortable bench to shoot from and, the gun will at least print on paper. If you are an excellent shot and never miss then you can skip the bench. I have only met one person like that and she out shot me all day long. The first thing you want to do is wipe the barrel and then fire a couple of caps, muzzle pointed to the ground, to clear any oil from the barrel. Next you must decide how much powder to use. BSA Policy is for us to use a set charge of 30 grains. It is a safe economical load that will work in virtually any caliber. Your next step is to select a patch

and lubricant. I'd start with a .010 or .015 patch. Use cotton material only. Save the exotic stuff for the idiot down the road. Lubricate the patch, start the ball and patch down the bore and seat them with your ram rod. My lubricant of choice is spit. Works good but at times the patches taste terrible. Kind makes you wonder where they've been. One thing about spit, it's tough to run out of.

Okay, now you're ready to shoot. Before you shoot, remember, you're not interested in anything but your group. If you're on the paper, your doing fine. After each shot wipe the bore with a damp patch, then a dry patch. When you reload, try to seat the ball with the same pressure each time. Make sure the ball is seated on the powder. (A marked ram rod is handy for this.) Don't beat the ball into the powder, just seat it firmly. After shooting five good shots that means no flinching, eyes open, etc., collect your target. Here is where the fun begins. By varying your patch, and lubricant you can adjust your group size. Some guns shoot best with tight patches and grease lubes, other do better with looser patches, or spit lube. The secret to success is to experiment and be consistent. Now I can help guide you on some of this, but the rest you have to do yourself. In my experience most black powder guns do well with a snug patch and ball combination. Snug is when the ball and patch can be started by hitting your ball starter with a sharp smack from your open palm. If you're a lady, a light tap from a plastic hammer head. If you have to beat the ball and patch in, then your deforming the ball. A good way to judge is to retrieve your patch, although this nearly impossible at a well-used range. Look for cuts in the patch, a sure sign that the patch is too tight. Also look for burned edges, a sign that the patch was too loose. Anything in between is good. I like to shoot five to eight shot groups. After each group I remove the target and mark the patch, and lubricant on the target. These become my reference points and records. Ideally as you work through the process, you will see your group tighten up and then widen.

After I have determined the powder charge, I start varying the patch and ball combination. Depending upon how tight the original combination was, I might try slightly heavier patch material or a different type. Sometimes a pillow tick seems to work better than straight patch material. If I see an improvement, using my best powder load, then I try a lighter patch and slightly large ball. Or at times I go the other way. Each gun is different. Finally I vary the lubricant. Remember always try to remain consistent and keep a record.

Working up a load is an easy but time consuming process. Of course and trip to the range is better than yard work. It may take several trips to the range to get close and a lot more to get the ultimate group. But with your gun holding a 3/4" group at 25 yards you'll be one step closer to that 50-xx score.

Black Powder Supplies

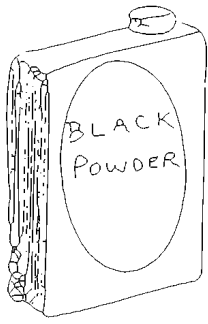

Black powder

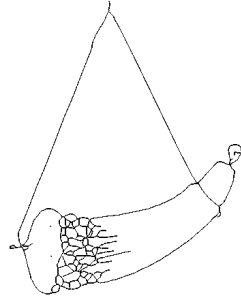

Powder horn



Powder flask



Brass



Antler

Powder Measure



Commercial made

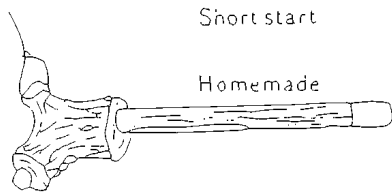

Short start

Homemade

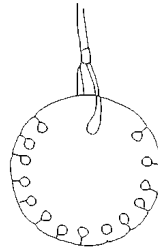

Cap patch



Capper



Caps

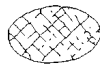

Patch

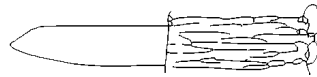

Patch knife



Balls (lead)

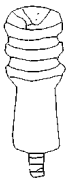

Cleaning jag

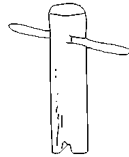

Nipple wrench

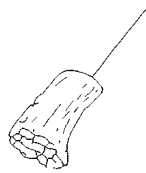

Nipple pick



Worm



Ball puller



Cleaning rags



Cleaning patches

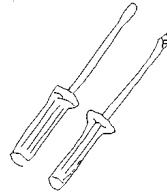

Tools



Gun oil



Cleaning solution

Muzzleloading Safety

Adapted from an article by Rick Kindig

All of the basics of safe firearm handling that apply to modern guns apply to muzzleloading firearms as well. However, in addition there are a few special considerations:

- Use only Pyrodex. Never use any type of modern, smokeless powder. The "black" in black powder refers to more than color. Black powder has a totally different chemical formula than smokeless.
- Always seat the projectile directly onto the powder charge, never leave a bullet part-way down the bore. If you fire many shots without cleaning the bore in between, you may reach a point where the bore is so heavily fouled that you can't seat the next round. If a bullet should become stuck part-way down the bore, don't try to shoot it out as it could burst, or at least bulge, the barrel. If necessary, drive the bullet down with a heavy rod and a hammer, then fire it. Failing this, pour several tablespoons of solvent down the bore. In a few minutes the solvent will dissolve the fouling holding the bullet, allowing it to be removed with a bullet puller attached to your ramrod.
- Many shooters have experienced the situation in which the percussion cap will fire, but the gun will not go off. In nearly every case this is a direct result of improper or incomplete maintenance. When this occurs, keep the muzzle pointed in a safe direction for at least one minute, in case a delayed ignition or "cook off" should occur. Often times a second or third cap will fire the piece.
- Questions often arise about transporting or storing a muzzleloading rifle with a charge in it. Check the law in your own state, but in Ohio it is legal to carry a muzzleloading firearm in an automobile this way, as long as it is not primed. While this is legal, it is NOT safe, nor is it recommend. Many hunters want to leave a rifle loaded overnight if they expect to hunt the next morning. If a rifle is left loaded and then plans change, it is quite possible to forget the rifle is loaded, creating a potentially deadly situation days or even months later. We know of one hunter who unknowingly left a muzzleloading rifle loaded from one season to the next. When preparing for the next season, he snapped a cap and shot a hole in his gun room wall. He was lucky. We strongly recommend emptying the rifle by firing, pulling the bullet and dumping the powder, or discharging the load with a CO2 ball discharger. While this may cost a little time, labor and material, it is the safe way to transport or store the firearm. There have been cases reported in which a rifle was discharged when there was no cap in place. Apparently a trace of priming material stuck to the nipple when the cap was removed, and this ignited the next time the hammer was dropped. If you choose to leave a rifle loaded overnight, de-prime it, lock it in a safe place, and mark it as loaded with a sign. Don't take a loaded rifle from a cold outside environment into a warm and humid building, as condensation will likely cause a misfire the next morning.
- Black powder and Pyrodex are stable products that can be handled and stored safely. Store in the original container and protect them from fire and humidity. Neither one is sensitive to shock under normal conditions. Two high-risk situations involving powder are:

Smoking while using powder.

Unauthorized use by a non-shooter (i.e. amateur use in fireworks).

Neither of these situations should be allowed to exist. Black powder and Pyrodex must be respected and used properly, but both can be used safely with a little common sense.

Powder Horns

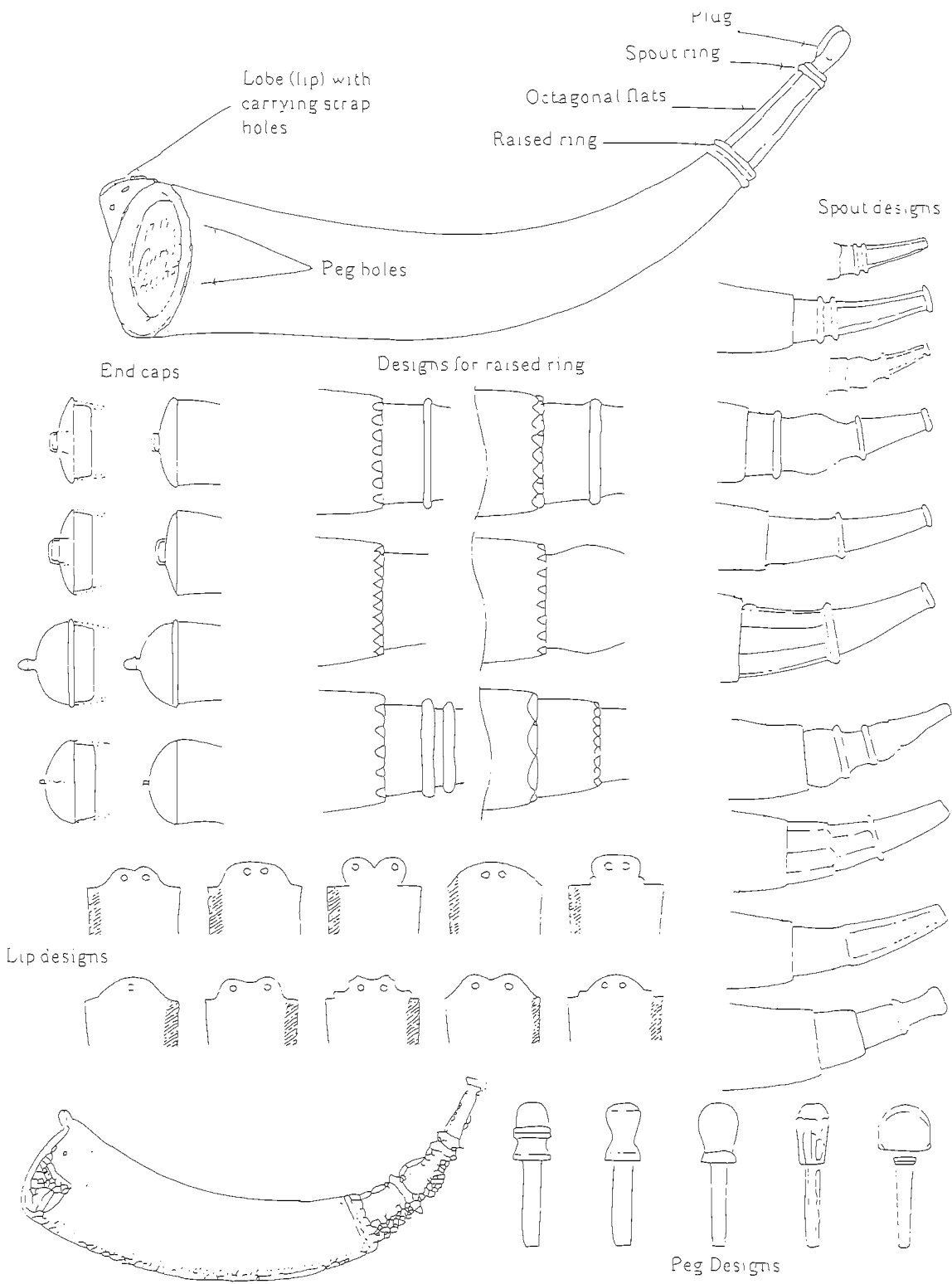

Team Building Games

One of the keys to success at the rendezvous for your Squad and Team is Teamwork. By preparing ahead of time you can truly act as a team and succeed beyond any possible individual efforts of one person. Here is some activities that will help you build teamwork among your team. Begin preparing today by including one of these activities at each of your team meetings.

Birthday Line-up

Have your team line up in order of their birthdays (month and day, year isn't necessary). The trick is, they CAN NOT TALK AT ALL. You'll find they resort to sign language, nudges, someone might try to start directing, etc. Variations include no talking, blindfolded, mute and deaf, etc. (communication)

Group Knot

Have your team stand in a tight circle, with their hands in the center. Then each person grabs another's hands at random. The puzzle is then for the whole group to work together to get themselves untangled without letting go of hands. Sometimes you'll find that the group has actually formed several smaller circles. This may get frustrating if you've formed a troublesome knot, but let them keep trying.

Loop-de-loop

Have your team stand in a circle and hold hands. Start one hula hoop (or innertube, long loop of fabric, etc.) hanging over one pair of joined hands. Each person in the circle must pass the hoop/loop over him/herself and on to the next person - WITHOUT letting go of hands. This can also be done with 2 or 3 loop/hoops going at the same time in different directions.

Keep the Ball Up

Using a beachball, have team members start hitting it around and trying to keep it off the ground. Then challenge them to keep it in the air for 20 hits, or 30 hits, etc. Encourage them to develop some strategy (such as establishing "zones", or an order, etc.) to try to keep the ball up for as many hits as possible.

Oath / Law Puzzle

Write out the oath and law on pieces of two foot by two foot 1/4 inch masonite. Use a jigsaw to cut out each word so when done, each word is on a separate piece of the puzzle. Take turns in groups of four putting the puzzles together. The groups can be timed to see which group is the fastest to assemble the puzzles. Not only will this help them learn the oath and law really well, It will also forced them to work as a team if they want to be the winners.

Stick

Everyone in group touches stick at same time. Break stick in half and repeat. Continue until stick is very small. (it's easier to start with a simple goal and work up to a harder one...)

Tree Climbing

Have group climb a tree holding hands or have group cooperate to climb a tree without low branches.

Minefield

Have group discuss things that are detrimental to functioning as a group. For each characteristic/action, throw an object into the playing space, the "minefield." Have group choose partners. One partner is blindfolded at one end of field. The non-blindfolded partners stand at the opposite end of the field and try to talk their partners through the minefield without running into any of the obstacles.

Three Balls

Have group pass 3 balls/objects through the group consecutively in the shortest possible time. Choose your words carefully and remember them exactly so that the instructions can be repeated when asked. (different ways to do things, cooperation)

Poison Peanut Butter

Draw two lines to represent the edges of the poison peanut butter. Hand group bandannas. Group needs to get everyone safely across using only the bandannas as safety zones. Variations include using too few bandannas for a continuous chain across or stating that once a bandanna has been placed on the ground, it cannot be moved. In the second case, be sure there are enough bandannas to make it across if placed strategically. (must plan ahead)

Group Juggle

Establish pattern of tosses including everyone in a circle. Add additional objects periodically.

A variation to help a group of strangers remember at least one person's name forever.

1. Have the group stand in a circle, fairly close together.
2. Toss a ball across the circle, calling out the player's name to whom you toss it to. That player tosses to a different player and so on until everyone has caught the ball and thrown it on once. It should be back in your hands at this point.
3. Repeat the sequence a couple of times. Add a second ball and then a third. Add as many balls as you want.

Variations? Make a wide circle out of doors.
Use toilet paper instead of balls.
Use various size balls.
The game ends when no one will play anymore.

Canyon Bridge

Two groups meet on a log/bench/etc. (the bridge) The groups need to pass each other to get to the other side of the canyon. Anyone who falls off goes to the end of their group.

Canoe/Rowboat

Lay a board out to a boat a few feet from the end of a dock. Everyone needs to get into the boat.

Boat Paddling

A group needs to complete a boat course around buoys or other objects without the aid of paddles or oars.

Trust Falls

One partner falls backwards with other partner spotting. Variations include forward falls where partners extend arms and fall toward each other, connecting hands. This can be done from fairly far apart provided there are spotters ready to catch the fallers in the middle. (editor's note: Trust falls must be highly supervised, in case scouts decide to experiment. Also a variation where there are at least 2 spotters, legs spread, one in front of the other, works well. For older scouts.)

Wind in the Willows

A variation on trust falls involving the entire group. Group stands in a circle with one person in the middle. Person in middle falls in any direction, trusting spotters to catch him/her and stand him/her back up

Blind Walk

Divide group into pairs with one member of each pair blindfolded. Seeing partner leads blind partner on a walk. The walk should be challenging, including such obstacles as climbing over tables, crawling under chairs, walking up or down stairs, climbing over railings, etc.

Blanket Volleyball

Divide group into two teams, each with a blanket held like a parachute. Toss in an object that is volleyed from team to team using the blanket for propulsion. Can add objects.

Trolley Walk

Group coordinates efforts to walk while standing on wooden trolleys (long boards with ropes to hang on to every few feet).

Group Jump-Rope

Given long piece of rope, group tries to jump rope simultaneously (again, easier to start with simple task - one or two people - and work up to larger goal gradually)

Blind Shapes

Group is blindfolded or with eyes closed. Have group form themselves into a square or a triangle, etc. Can use a rope with everyone holding on. (communication, leadership)